

# Handset Operations Manual

## RTX 8430



# Table of Contents

1	About This Document.....	5
1.1	Audience .....	5
1.2	Abbreviations.....	5
1.3	References/Related Documentations.....	5
1.4	Document History.....	5
2	Making Handset Ready.....	6
2.1	Package - Contents/Damage Inspection .....	6
2.1.1	Before the Package Is Opened.....	6
2.1.2	Contents of the Package.....	6
2.1.3	Damage Inspection .....	7
2.2	Before Using the Phone .....	7
2.2.1	Installing the Battery .....	7
2.2.2	Using the Charger .....	7
2.2.3	Handset in the Charger.....	7
2.2.4	How to Open Back Cover.....	7
2.2.5	How to Replace Battery .....	8
2.2.6	Handset Serial and IPEI/IPUI Number.....	8
3	Phone Overview .....	9
3.1	Handset – Front View.....	9
3.2	Rear View – Handset.....	10
4	Display .....	11
4.1	Icons and Text in the Display .....	11
4.2	Menu icons.....	12
4.3	Keys and Buttons .....	13
4.3.1	Navigation Keys/Selection Key .....	13
4.3.2	Softkeys .....	13
4.3.3	Off-hook Key.....	13
4.3.4	On-hook, and On/Off Key.....	13
4.3.5	Speed Dial Keys.....	13
4.4	The Keypad .....	14
4.4.1	Idle Mode, and Number Input Mode .....	14
4.4.2	In Text Input Mode .....	14
4.4.3	Silent Mode from #-Key.....	14
5	Basic Operation .....	15
5.1	How to Switch the Handset On/Off .....	15
5.2	Lock/Unlock the Keypad .....	15
5.3	Entering a Number in Idle .....	15
6	Menu Operation .....	16
6.1	Contacts .....	16
6.1.1	Add Contact.....	17
6.1.2	Call/Edit a Contact .....	17
6.1.3	More Contacts Options .....	17
6.1.4	Speed dial/One Touch Dial .....	18



6.2 Central Directory.....	19
6.2.1 LDAP Mode and Local Mode .....	19
6.2.2 Calling a Contact in the Central Directory .....	20
6.3 Calls.....	20
6.3.1 Call .....	21
6.3.2 View .....	22
6.3.3 More Calls Options .....	22
6.4 Connectivity .....	23
6.4.1 Register .....	23
6.4.2 Deregister .....	23
6.4.3 Select PBX .....	24
6.5 Settings .....	24
6.5.1 Time & Date.....	25
6.5.2 Language.....	25
6.5.3 LED Signal .....	26
6.5.4 Power Save .....	26
6.5.5 Security.....	27
6.5.6 Handset Name .....	28
6.5.7 Reset Settings .....	28
6.5.8 Status .....	28
6.5.9 Auto Answer .....	29
6.5.10 Silent Charging.....	30
6.5.11 Do Not Disturb.....	30
6.5.12 Hide Number .....	30
6.5.13 Call Forward.....	31
6.5.14 Idle Screen Saver .....	31
6.5.14 Idle Clock .....	32
6.6 Audio Settings .....	33
6.6.1 Silent Mode .....	33
6.6.2 Ring Volume and Ring Melody .....	33
6.6.3 Key Sound .....	34
6.6.4 Confirmation Sound.....	35
6.6.5 Coverage Warning .....	35
6.6.6 Charger Warning.....	35
<b>7 Calls Operations.....</b>	<b>36</b>
7.1 Incoming call .....	36
7.1.1 Answering an Incoming Call .....	36
7.1.2 Reject an Incoming Call .....	36
7.1.3 Silencing an Incoming Call .....	36
7.1.4 Ending a Call .....	37
7.2 Initiating a Call .....	37
7.2.1 Initiating a Call from Idle .....	37
7.2.2 Initiating a Call from Contacts .....	37
7.2.3 Initiating a Call from Calls.....	37
7.2.4 Initiating a Call from the Central Directory.....	38
7.3 Call Holding/Retrieving .....	38
7.4 Attended and Unattended Transfer of a Call.....	38
7.4.1 Attended Transfer .....	38
7.4.2 Unattended Transfer .....	39
7.5 Swap between Two Calls .....	40
7.6 Call Waiting .....	41
7.7 Conference Call .....	41



7.7.1 Establishing a Conference Call.....	41
7.7.2 Terminating a Conference Call .....	42
8 Accessories .....	44
9 Troubleshooting .....	44
9.1 Operational problems.....	44



# 1 About This Document

This document describes the features and functionalities available in the RTX SME VoIP DECT 8430 Handset. We describe how to operate the handset without going into details about its mechanical features. The reference for features and operation in this manual is RTX generic mode.

## 1.1 Audience

This guide is intended for everyday users as well as system administrators.

## 1.2 Abbreviations

For the purpose of this document, the following abbreviations hold:

- DECT: Digital Enhanced Cordless Telecommunications
- IPEI: International Portable Equipment Identity
- MAC: Media Access Control
- PBX: Private Branch Exchange

## 1.3 References/Related Documentations

- [1]: How\_To\_Deploy\_SME\_Network\_V1.4
- [2]: SME VoIP System Guide, Version 4.1

## 1.4 Document History

REVISION	AUTHOR	ISSUE DATE	COMMENTS
1.0	KMH	08-Oct-2014	First version.
1.1	KMH	23-Dec-2014	Aligned with firmware v323.14
1.4	KMR	14-April-2015	Aligned with firmware V324.6
4.1	HDJ	15-01-2018	Aligned with firmware v410
4.4	HDJ	05-10-2018	Aligned with firmware v440
4.5	HDJ	04-04-2019	Aligned with firmware v450

## 2 Making Handset Ready

In this chapter we briefly describe how to prepare the handset for use, install, and how to insert and charge new batteries.

### 2.1 Package - Contents/Damage Inspection

#### 2.1.1 Before the Package Is Opened

Examine the shipping package for evidence of physical damage or mishandling prior to opening. If there is proof of mishandling prior to opening, you must report it to the relevant support center of the regional representative or operator.

#### 2.1.2 Contents of the Package

Make sure all relevant components are available in the package before proceeding to the next step.

In principle, every shipped handset unit package/box contains the following items:

- 1 x Charger with A/C Adaptor
- 2 x Battery, AAA
- 1 x Handset Unit, 1 x Battery cover

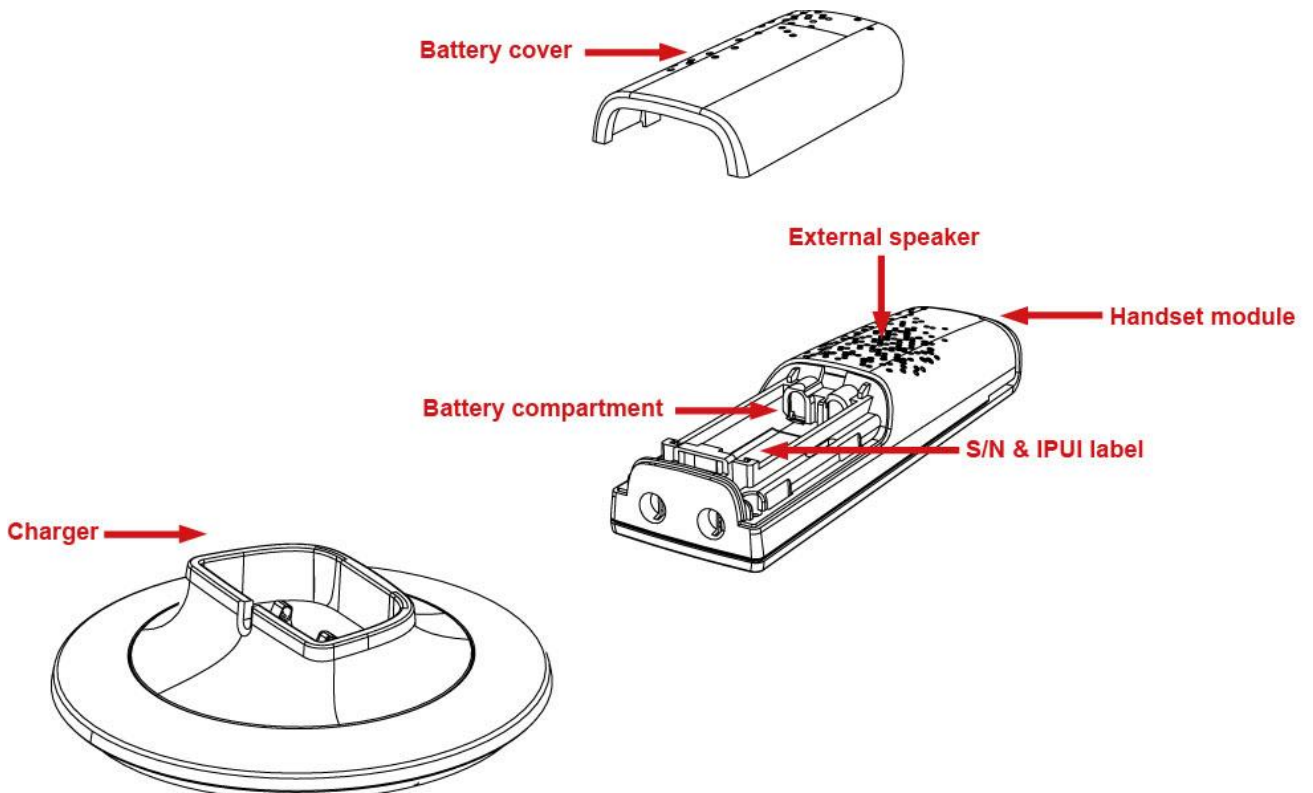



### 2.1.3 Damage Inspection

The following are the recommended procedure for you to use for damage inspection:

1. Examine all relevant components for damage.
2. Make a “defective on arrival - DOA” report or RMA to the operator. Do not move the shipping carton until the operator has examined it. The operator/regional representative will initiate the necessary procedure to process this RMA. They will guide the network administrator on how to return the damaged package if necessary.
3. If no damage is found, then unwrap all the components and dispose of empty package/carton(s) in accordance with country specific environmental regulations.

## 2.2 Before Using the Phone

The following are the precautions users should read before using the handset:

### 2.2.1 Installing the Battery

1. Never dispose battery in fires, otherwise it will explode.
2. Never replace the batteries in potentially explosive environments, e.g. close to inflammable liquids/gases.
3. ONLY use approved batteries and chargers from the vendor or operator.
4. Do not disassemble, customize, or short circuit the battery

### 2.2.2 Using the Charger

Each handset is charged using a handset charger. The charger is a compact desktop unit designed to automatically charge and maintain the correct battery charge levels and voltage. The handset charger is powered by AC supply from 110-240VAC that supplies 5.5VDC at 600mA. When charging the battery for the first time, it is necessary to leave the handset in the charger for at least 10 hours before the battery is fully charged, and the handset is ready for use.

### 2.2.3 Handset in the Charger

For correct charging, ensure that the room temperature is between 0°C and 25°C / 32°F and 77°F. Do not place the handset in direct sunlight. The battery has a built-in heat sensor which will stop charging if the battery temperature is too high.

If the handset is turned off when placed in charger, the handset turns on and shows (shortly) the charging message “The battery is charging”. After a while the display backlight first dim and then turns off (if demo mode is not enabled). In this state, the handset will still respond on for example incoming calls.

If the handset is turned on when placed in charger, the display shows (shortly) the charging message “The battery is charging”. After a while the display backlight first dim and then turns off if unless “Idle Screen Saver” is switched on.

### 2.2.4 How to Open Back Cover

1. Press down the back-cover lock and lift the back cover away from the handset.
2. Remove the back cover from the handset.

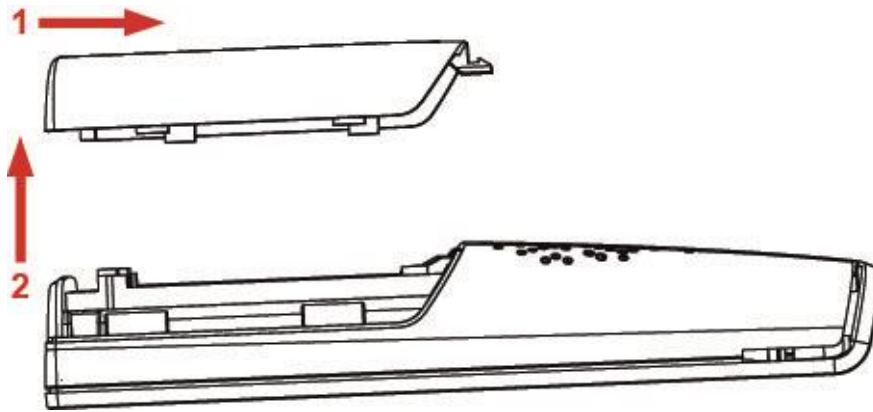

## 2.2.5 How to Replace Battery

Remove the back cover from the handset as showed in section 2.2.4 *How to Open Back Cover* above. Then remove the old battery and replace it with a new one.

## 2.2.6 Handset Serial and IPEI/IPUI Number

The serial number and IPEI/IPUI number of each handset are found either on a label which is placed behind the battery, or on the packaging label. First, lift off the handset back cover, lift the battery, and read the serial number.

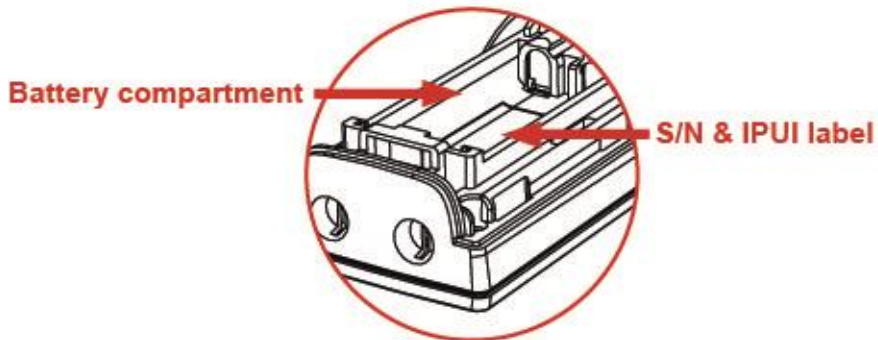



## 3 Phone Overview

This section contains an overview of the handset from a front and a rear view.

### 3.1 Handset – Front View

1. Earpiece Speaker
2. Screen
3. Navigation Keys (Up/Down/Right/left)
4. **Selection Key (Centre of Navigation Keys)**  
This functions as the activity menu key. Press this in idle to enter all the menus available on the handset.
5. **Call Key/ Accept Call Key (Off-hook key)**  
Press to answer a call, and it functions as a shortcut to the call list.
6. **End, ON/OFF Key, Back Key (On-hook key)**  
Press to end call, to return to a previous menu, and to switch the handset on/off by long-press.
7. **Right Softkey**  
Are used for different commands in the different menus on the handset, and it changes according to what is displayed on the screen.
8. **Left Softkey**  
Are used for different commands in the different menus on the handset, and it changes according to what is displayed on the screen.
9. Numeric Keypad

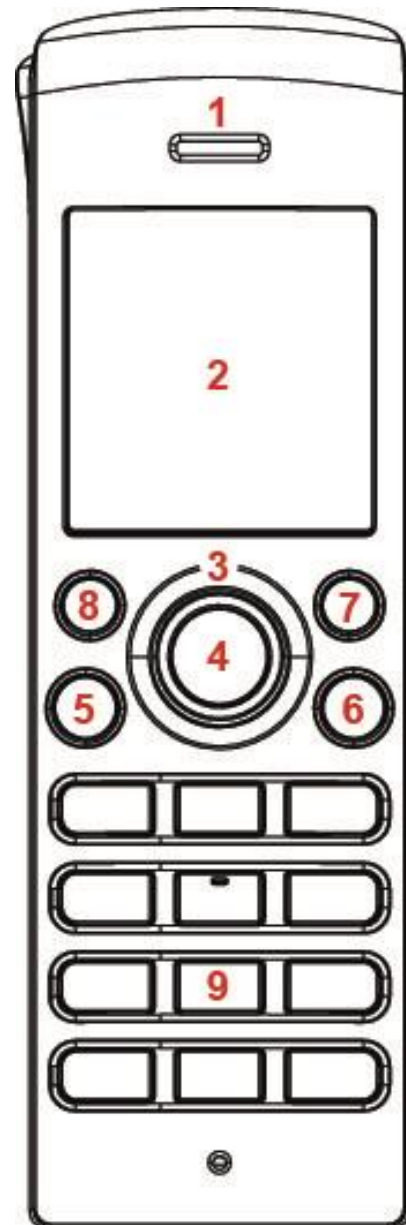

## 3.2 Rear View – Handset

**10. Headset connector (3.5mm)**

This is for connecting a headset. The connector is protected against dust by the headset connector cover.

**11. External Speaker**

Is used for ringing, alarms, and when speaker mode is enabled in call.

**12. Battery**

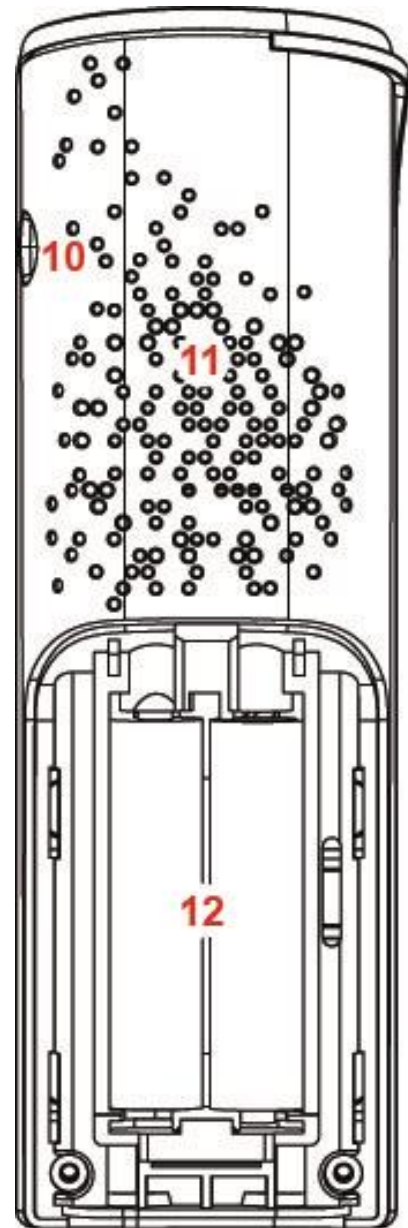

## 4 Display

This section contains a description of the different icons seen in the idle and in the menu.

### 4.1 Icons and Text in the Display





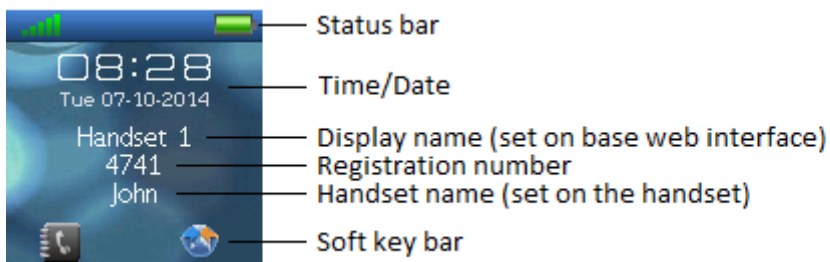



All functions and settings available to the handset user are shown as icons and text in the display. The icons and text in the display indicate functions and settings to which you have access.

The picture below shows a typical idle screen that displays the time and date, display name (which is set on the web interface of the base station), registration number, and handset name which is set locally on the handset. This active area is also the area for a dialog window text if there has been a missed call, or if an action needs to be confirmed.



In the softkey bar at the bottom of the idle screen it is possible to access from the left: Contacts and Central Directory.

The status bar at the top of the idle screen is always visible in all screens. This displays icons which give the user information about signal strength, missed call, new voicemail message, phone lock, key lock, sound off, time, and battery status. These icons are shown and explained shortly in the following:

-  "Signal strength" icon is always visible in the upper left corner. The number of green staples are displayed according to the strength of the signal.
-  "Battery" icon is always visible in the upper right corner, and shows how much battery that is left on the handset.
-  "Full battery" icon is displayed when the handset is fully charged.
-  This battery icon is displayed when there is 20% to 32% battery left on the handset.
-  "Low battery" icon is displayed when there is 10% to 20% battery left on the handset.
-  "Missed call" icon is displayed in the status bar, and indicates that there has been a missed call which can be seen in the call list.
-  "Voicemail message" icon is displayed in the status bar when there are voicemails that have not been listened to. This icon remains until the voicemail has been listened to.
-  "Sound off"/"Silent" icon is displayed in the status bar when silent mode is enabled on the handset.
-  "Keylock" icon indicates that the keypad is locked, and the user needs to long-press the \*-key to be able to use the handset again.

- ☒ “Do not disturb” icon is displayed in the status bar when this feature is enabled; in this case the handset does not react on any incoming calls.
- HD “HD” icon is displayed during a call if the quality of the call is “High Definition” and hereby using the 722 codec (also called a wideband call).

## 4.2 Menu icons

All the menus available on the handset are displayed when the menu key is pressed from idle. The available menus are seen in the screen below.

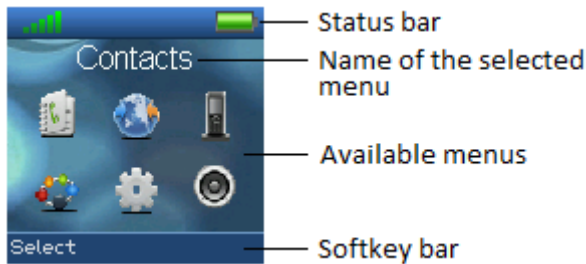

The status bar at the top of the display is always displayed independent of which menu is selected, and the softkey bar shows the possible options to select in every menu. In the active area of the screen the name of the selected menu is displayed at top, and the available menus to select are displayed. During navigation across the different menus the highlighted icon is moving to indicate where the navigation key is. The menu icons are showed and shortly explained in the following:



The “Contacts” menu contains all names/numbers in the local phonebook.



The “Central directory” menu contains all names/numbers in the central directory of the system. This is set up in the web interface of the base station system (see the additional base station manual document for further information on this via [2])



The “Calls” menu contains call lists and call times.



The “Connectivity” menu contains options to register/deregister the handset and network options.



The “Settings” menu contains personal handset settings such as time/date, language, handset name, etc.



The “Audio settings” menu contains personal handset settings for the audio profile such as ring volume, ring melody, etc.

## 4.3 Keys and Buttons

### 4.3.1 Navigation Keys/Selection Key

Use this key when navigating in menus, and to move the cursor when writing some text or a number. The

navigation keys  are used for stepping left/right and up/down when navigating in the menus. When selecting or entering a menu use the selection key in the middle of the navigation keys. This key is also used when entering the activity menu from idle. In call, the up/down keys adjust the volume and the left key enables/disables the mute function.

### 4.3.2 Softkeys

The handset has two softkeys  located just beneath the display, and the function of each one is indicated by the text in the display just above each softkey according to the respective screen.

### 4.3.3 Off-hook Key

This key  is used for answering an incoming call, or dialing a number either directly from the idle, or from the contact list, call list, or central directory. Pressing this key in idle opens the call list, and pressing the key in call activates the speaker mode.

### 4.3.4 On-hook, and On/Off Key

The On-hook key  is used for disconnecting calls, and returning to the previous menus when navigating in any menu. A long-press in idle will switch the handset off, and a long-press when the handset is switched off will switch the handset on.

### 4.3.5 Speed Dial Keys

Any key from “2” – “9” can be set as a speed dial key. A long-press on any of these numbers when the handset is in idle can be set to a shortcut to calling any contact in the contact list, or in the F-Key list. For additional information on this feature see [7.1.4 Speed Dial/On Touch Dial](#).

## 4.4 The Keypad

The keypad is used when entering a name or number, and the sketch below shows the available characters on the handset.

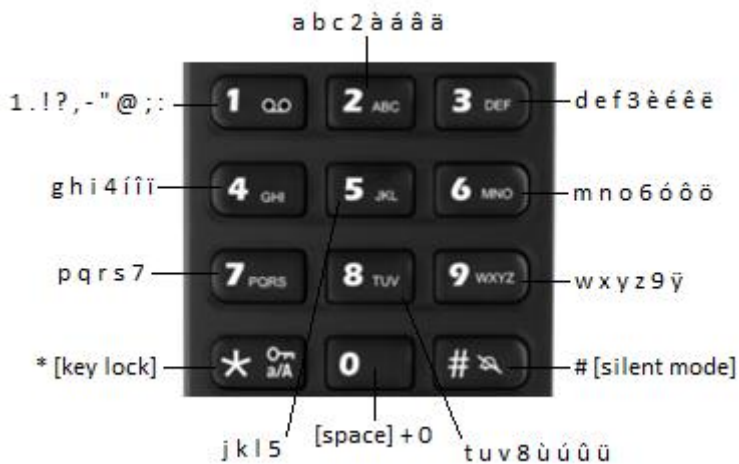

**NOTE:** Depending on the selected menu language, other characters can be available. Therefore the character order can differ from the table above.

### 4.4.1 Idle Mode, and Number Input Mode

When in idle a short press on a key enters the digits “0” – “9” and the characters \* and #. In number input mode, a long-press on “0” generates a +.

### 4.4.2 In Text Input Mode

While in text input mode a short press on a key 0-9 displays the first available character on that specific key. The marked character is then selected after a timeout, or when another key is pressed.

By pressing the \*-key it is possible to change the text to be upper/lower case or only numeric (Abc, abc, ABC, or 123).

Use the 0 to add a space in the text.

### 4.4.3 Silent Mode from #-Key

By long-pressing the #-key when the handset is in idle, the handset will turn to silent mode, and a “Sound Off” icon  will be shown in the status bar. This feature enables that the user rapidly can turn on silent mode. To turn off silent mode again long-press the #-key, or enter the “Audio settings” menu to disable silent mode.

**NOTE:** Please note that all audio settings, except from the silent mode option, will be greyed out when the handset is in this silent mode.

## 5 Basic Operation

The following explain three basic operations of the handset: how to switch the handset on/off, how to lock/unlock the keypad, and the available options when entering a number in idle.

### 5.1 How to Switch the Handset On/Off

Switching on the handset

To switch the handset on long-press the on-hook key  to switch the handset on. When the handset is on, it will display “Searching” for a short while until a signal is detected, and then the handset will show the registration number and is hereby ready for use.



**Switching off the handset**

To switch the handset off return to the idle screen and long-press the on-hook button , and the handset will turn off.

### 5.2 Lock/Unlock the Keypad

To prevent accidentally pressing the keys and making a call the keypad can be locked.

**Locking the keypad**

To lock the keypad long-press the  in idle, and the following text message is displayed: “Press and hold \*”. When the keypad is locked, the “Key Lock” icon  is displayed in the status bar.

**Unlocking the keypad**

To unlock the keypad long-press  until the text message “Press and hold \*” disappears.

**NOTE:** It is possible to answer/reject an incoming call while the keypad is locked.

### 5.3 Entering a Number in Idle

When entering a number in idle it is possible to call the number by pressing the off-hook key . Otherwise, the following two different options are available when a number is entered in idle.

**Save**

With this option the number can be added as a local contact by pressing the left softkey “Save”.

**Clear**

Using the right softkey “Clear” deletes one character at a time to the left of the cursor.

## 6 Menu Operation

In the following a description of the different menus and submenus on the handset will be given. Before the functions of every menu are explained a menu tree will be showed at top to give an overview of how to enter the different menus.

From idle it is possible to enter some of the menus directly via the two softkeys as displayed on the image below. By pressing the left softkey the menu “Contacts” is entered, and by pressing the right softkey “Central Directory” is entered.



To enter the menu from idle press the selection key in the middle of the navigation keys , and all the different menus can be entered:



### 6.1 Contacts

In this menu all the local contacts on the handset are displayed. Below both a full and an empty local phonebook is displayed.

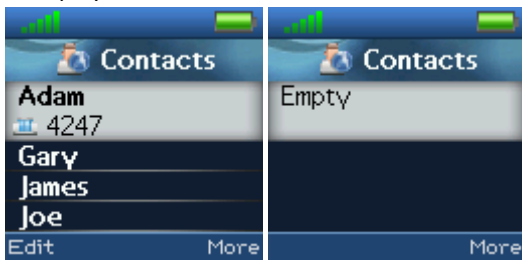



### 6.1.1 Add Contact

To add a new contact, press the right softkey “More”, select “Add contact” and the information displayed in the menu tree below can be filled out for the contact.

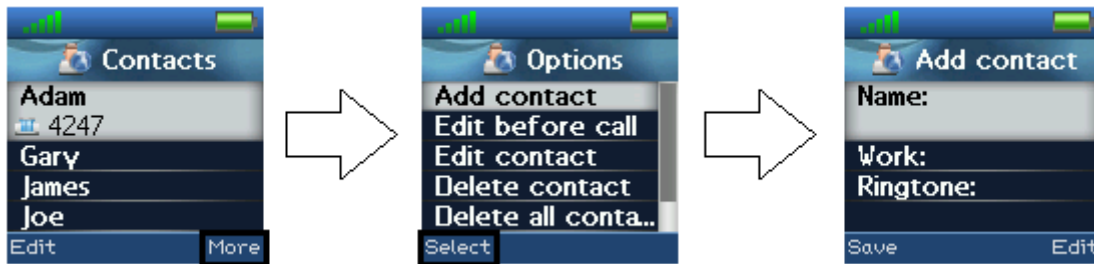



Hereby, it is possible to edit the name, add a work phone number, and add a specific ringtone to be used for this contact.

To save a new contact, press the left softkey “Save”.

### 6.1.2 Call/Edit a Contact

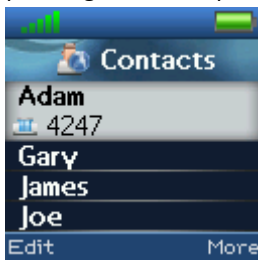
When the “Contacts” menu contains contacts, it is possible to edit each contact with the left softkey. When pressing “Edit” it is possible to edit the name, work, or ringtone for the highlighted contact.



To call a contact, scroll to the contact and when the contact is highlighted, press the green off-hook key .

### 6.1.3 More Contacts Options

When a specific contact is highlighted, pressing “More” in the “Contacts” menu enables the features seen below.



#### Edit before call

This function makes it possible to edit the number of the contact before calling the contact.

#### Edit contact

This has the same function as pressing “Edit” directly from the “Contacts” menu, and makes it possible to edit the name, work, mobile, home, other, or ringtone for the contact.

#### Delete contact

By selecting this feature, the following text message is displayed: “Delete current contact from local contact list?”

To delete the selected contact, press the left softkey “Yes”.

To go back to the “More” menu, press the right softkey “No”.

#### Delete all contacts

With this function all the contacts in the local contact list can be deleted, and by selecting this option the following text message is displayed: “Delete entire local contact list?”

To delete all contacts in the local contact list, press the left softkey "Yes".  
To go back to the "More" menu, press the right softkey "No".

## 6.1.4 Speed dial/One Touch Dial

With this feature it is possible to add a contact to the speed dial. Hereby, this contact can be called directly from idle by long-pressing the speed dial number that the contact is added to. The speed dial feature allows the user to assign a speed dial number (2 – 9) to a contact. This enables the user to call a contact by making a single long-press on one of the number keys (2 – 9) when in idle.

A contact can only be assigned to one speed dial number at a time. The first defined number of the contact will be dialed when the speed dial key is pressed. This means that if all numbers (work, mobile, home, and other) are defined for the contact then the work number will be dialed. If the work number is not defined, then the mobile number is dialed etc.

**NOTE:** The '1' key is reserved for voicemail. Long key press on '0' is used for starting a normal dial string with '+'.

How to setup speed dial

**Prerequisite:** There must be at least one contact in the contact list.

Steps:

1. Go to the contact list > scroll to the contact that you want to assign a speed dial number to.
2. Select "More" > select "Speed dial"
3. Move to the speed dial number (2 – 9) that you want to assign the contact number to.
4. Select "Add". The contact name should be appended to the speed dial number.
5. Leave the speed dial list by pressing the red "On-hook" key. Press the "On-hook" key to exit "More" menu, and exit the contacts list by pressing "On-hook" key again.

The images below illustrate how the local contact 'Adam' is added as a speed dial number to 2.

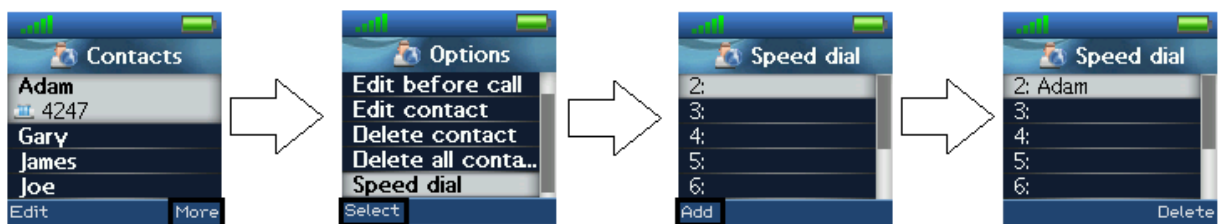

How to call a speed dial number

**Prerequisite:** The handset is in idle and the key lock is not active.

Steps:

1. Make a long key press (> 2 seconds) on a speed dial key that is assigned to a contact. The first number defined is dialed.

This way the local contact 'Adam' can be called directly from idle by long-pressing  as displayed below:



## 6.2 Central Directory

In the “Central directory” menu different contacts can be called according to which list the system administrator has setup in the base system. This menu can be entered directly from idle with the right softkey 



Otherwise the menu can be opened by pressing the selection key  in idle and choosing “Central directory”.



### 6.2.1 LDAP Mode and Local Mode

The “Central directory” can be set to LDAP Mode or Local Mode via the web interface of the base station (see [2] for additional information on this).

When set to LDAP mode, opening the central directory will show a search screen as displayed in the following. By leaving the search field empty and pressing the middle softkey “Search” all the contacts in the central directory will be displayed.



**NOTE:** When the central directory is in LDAP mode pressing right softkey “Search”, the handset will return to the “Search” field and a new search for a contact can be made. Pressing the red “On-hook” button in the central directory will send the user back to idle.

If the central directory instead of LDAP mode is set to Local mode, opening the central directory will get you directly to browsing mode. To enter search mode press the right softkey as displayed below.



The search function is similar in these two modes. When typing something in the search field, and pressing search the results of the search will be displayed. This is showed in the following images.



To scroll through the search results, use the navigation keys up and down. If a green arrow is seen to the right of a contact (as seen above), this contact has more than one number assigned. To scroll through these different numbers, use the left/right navigation keys.

### 6.2.2 Calling a Contact in the Central Directory



To call a contact from the central directory, press the green “Off-hook” button and the contact number that currently appears on the screen will be called.



If a contact has more numbers assigned, a green arrow is shown to the right of the contact. By pressing the right/left navigation keys it is possible to navigate between the different numbers assigned to that contact. The number that currently appears on the screen is the one that is called.

### 6.3 Calls

The menu “Calls” is a list of all the calls that have been made to or from the handset.

This menu can be entered by pressing the green off-hook button , or from the menu by pressing the selection key  and choosing “Calls”.



Use the up/down navigation keys  to scroll through the list. The list contains all the different call types (including both outgoing and incoming) that have been made to or from the handset.

When there is a missed call on the handset, a red icon  is displayed in the status bar until the entry has been viewed in the “All calls” list. As shown in the images below, the information displayed about the missed call in the call list is in bold text until the entry has been scrolled over once.



When the entry has been displayed once, the text displaying call information is no longer bold and the red missed call icon disappears from the status bar, indicating that the user has seen missed call.

### 6.3.1 Call

To initiate a call directly from the local call list, use the up and down navigation keys to highlight an entry and

press the green off-hook button . This will initiate a call to the highlighted entry as displayed in the images below.

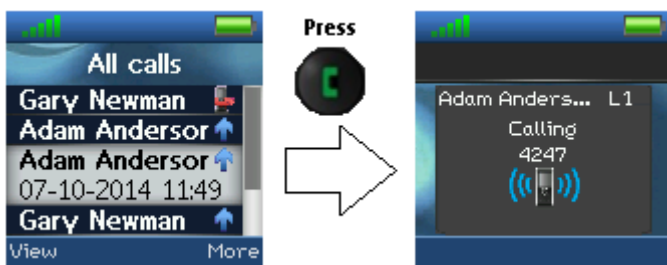

### 6.3.2 View

The left softkey enters a “View” function for each entry. With this feature the following details of the call can be seen: number, status (answered, dialled, missed), duration, and time stamp as displayed in the image below.



### 6.3.3 More Calls Options

When a specific call is highlighted, pressing “More” in the “Calls” menu opens the “Options” submenu below.



#### View details

This shows the same details about the call as the “View” function explained in 7.3.1 Call/View.

#### Save as contact

With this feature it is possible to save the number in the call list as a contact.

#### Append to contact

This function makes it possible to add the number in the call list to an existing contact.

#### Edit before call

With this function the number in the call list can be edited before calling.

#### Delete item

By selecting “Delete item” the following text message is displayed: “Delete current item from list?”

To delete the item from the call list, press the left softkey “Yes”.

To return to the call list, press the right softkey “No”.

#### Delete all items

This feature makes it possible to delete all items in the specific call list. By selecting “Delete all items” the following text message is displayed: “Delete all items in this list?”

To delete all items in the specific list, press the left softkey “Yes”.

To return to the call list, press the right softkey “No”.

## 6.4 Connectivity

The “Connectivity” menu is entered in the menu by pressing the selection key  in idle and choosing this menu.



In this menu it is possible to register or deregister the handset to a certain base system.

### 6.4.1 Register

When a handset is to be registered on a base system, the user will be prompted for an access code (base registration PIN) before the registration procedure is started.

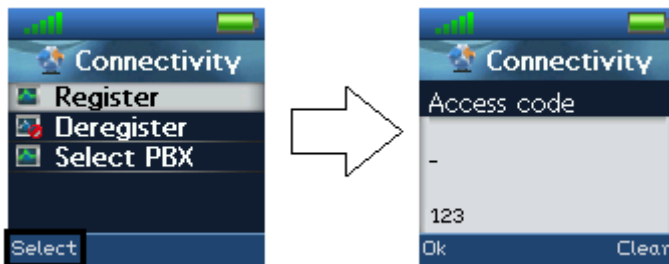

The access PIN code is default “0000” and cannot be changed via the handset. The access PIN code can only be changed via the web interface on the base (please check the additional document via [2] for more information about handset registration on a base system).

### 6.4.2 Deregister

The handset can be deregistered from a base station system. When deregistering a handset, the user will in this case be prompted for a PIN code (base deregistration PIN), the PIN code is default “0000” and cannot be changed via the handset. This is displayed below.

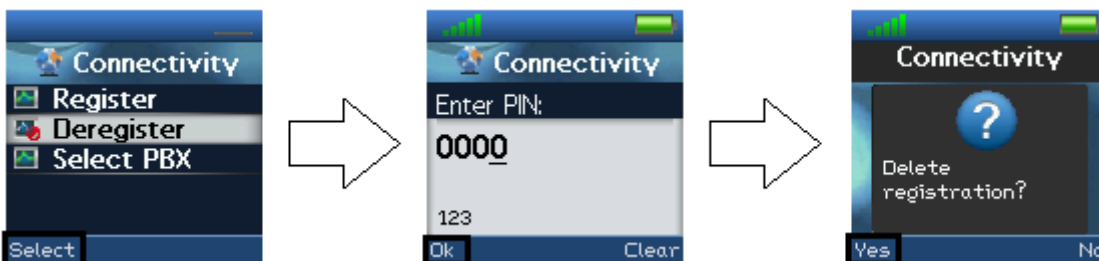

When the registration that should be deregistered is selected, a warning message “Delete registration?” will be displayed as seen above. The user must accept the deletion by pressing the left softkey “Yes”. The right softkey “No” cancels the operation.

### 6.4.3 Select PBX

In the “Select PBX” menu it is possible to select another PBX for the handset to use.



With this feature it is possible to connect the handset to another PBX than the one used by the base station system. In this way, the handset can for example function on a PBX without being connected to a system of base stations.

### 6.5 Settings

The “Settings” menu is entered through the menu by pressing the selection key  in idle.



The “Settings” menu contains the following personal handset settings:

SETTINGS	
Time & Date	
Language	
LED Signal	
Power save	
Security	
Handset name	
Line	
Reset settings	
Status	
Auto answer	
Silent charging	
Do not disturb	
Hide Number	
Call Forward	
Idle Screen Saver	
Idle Clock	

Each of these settings will be described in the following.



### 6.5.1 Time & Date

To set the time and date in the handset select the “Time & date” menu. Below it is shown how the time and date format can be changed.



To change the time use the keypad, or the navigation keys to set the time to be what you want, and press save; as seen in the third image. The time format can also be changed by pressing the right softkey “Format”. In “Time format” the preferred time format (24 or 12 hours) can be selected. In the same way the date can be changed as seen in the images below:

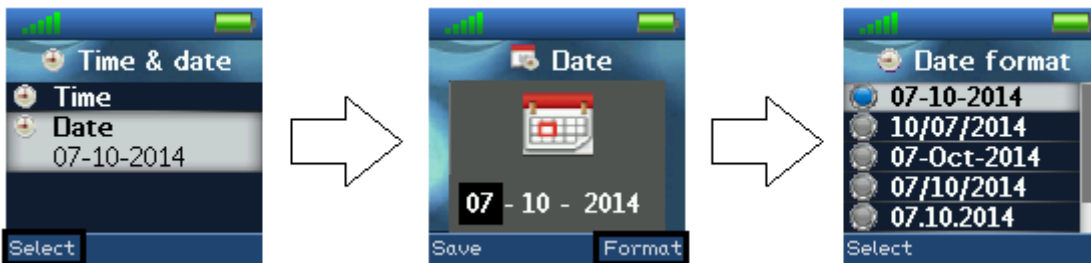

In “Date format” the preferred date format (e.g. dd-mm-yyyy) can be selected by using the up/down navigation keys.

### 6.5.2 Language

In this menu it is possible to select between different languages for the handset. The menu tree below shows the different languages available on the handset.

SETTINGS	
LANGUAGE	
English	
Español	
Deutsch	
Français	
Italiano	
Nederlands	
Português	
Dansk	
Svenska	
Türkçe	
Polski	
Norsk	
Russian-1	
Russian-2	
Hrvatski	
Srpski	
Slovenian	

The currently applied language is displayed when highlighting or selecting the menu “Language”.

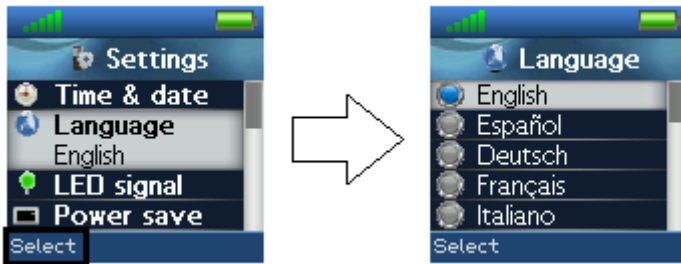

When entering this menu, a specific language can be selected by pressing the left softkey “Select”. Scroll through the list by using the up/down navigation keys.

### 6.5.3 LED Signal

The LED at the upper left of the handset blinks green and can be assigned to distinctive situations by the user.

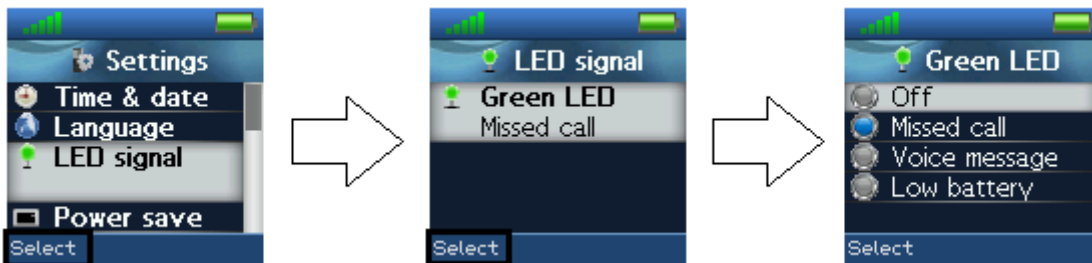

The green LED can be configured to blink at the following events:

#### Missed call

The green LED signal blinks when there is a missed call.

#### Voice message

The green LED signal blinks when there is a voice mail message that has not been listened to.

#### Low battery

The green LED signal blinks when the battery is low (below 20% battery on the handset).

#### Off

The LED signal is disabled, and does not blink in any situation.

### 6.5.4 Power Save

The power save option makes the handset less battery consuming by turning off the display after a certain amount of time.



In the images above, it is illustrated how the power save can be set between 5 seconds and 60 seconds. An interval is chosen by pressing the left softkey “Select” when the desired item is highlighted.

### 6.5.5 Security

In the “Security” menu it is possible to set an automatic keylock and change the PIN of the handset.

#### Phone lock

This feature locks the phone, when the it is in standby mode. The code needs to be entered before the phone can be accessed.

**NOTE:** No action is possible without the code, incl. Power off

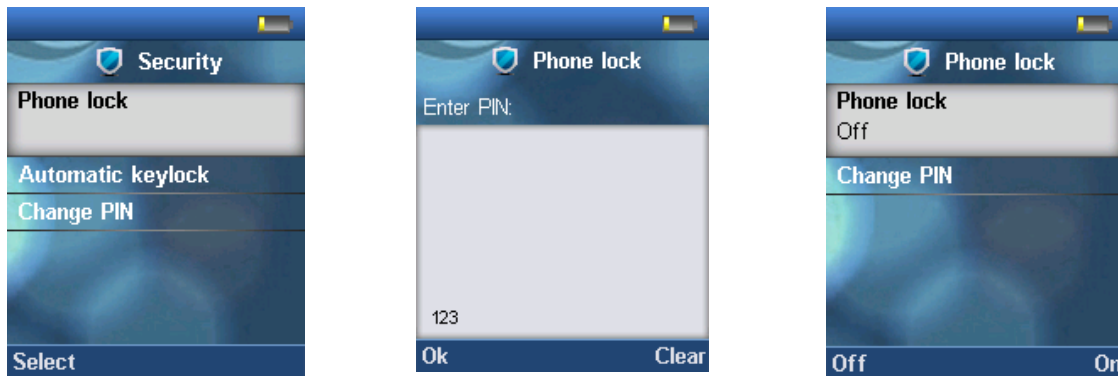

**NB:** above screen shots are from RTX8630, but content is the same.

After activating the Phone Lock the handset need to be rebooted, for this to take effect.

To unlock the phone press and hold the  key and enter the access code.

#### Automatic keylock

If the “Automatic keylock” feature is enabled, the keypad will lock automatically after a certain amount of time that the handset has not been used. The currently applied setting is displayed when highlighting or selecting the menu “Automatic keylock”.



A list of selectable timeouts is displayed when the user enters the “Automatic keylock” menu. Any one of these can be selected by pressing the left softkey “Select” when the desired time interval is highlighted. Afterwards, when the handset has been inactive in the selected time interval, the keypad will lock automatically.

**NOTE:** It is not possible to use the keys when these are locked. The user has to unlock the keys by long-pressing

. Only emergency numbers (e.g. 911) can be called without having to unlock the keypad.

#### Change PIN

In “Change PIN” the handset security PIN code can be changed – as an example the PIN code is used when

settings are reset.

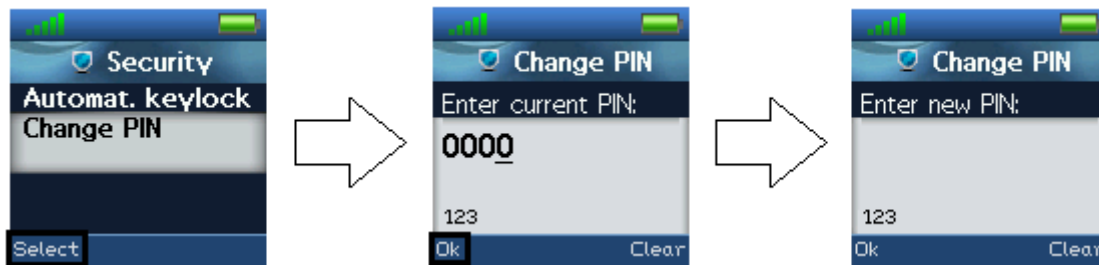

The current PIN code must be entered first to change it to a new PIN code.

### 6.5.6 Handset Name

#### Handset name

By selecting “Handset name” the name of the handset can be changed.



An editor is displayed when entering the menu. The handset name is typed in using the numeric keys and afterward pressing the selection key to save the name. The handset name is displayed in the third line of the idle display.

#### Line

If the handset is used in a multiline environment, it is possible to select preferred lines for the handset to make outgoing calls from in the “Line” menu.

NOTE: To see additional information on this “Line” feature, please check the base system document via [2]

### 6.5.7 Reset Settings

The handset settings can be reset to default settings by selecting this menu “Reset settings”.

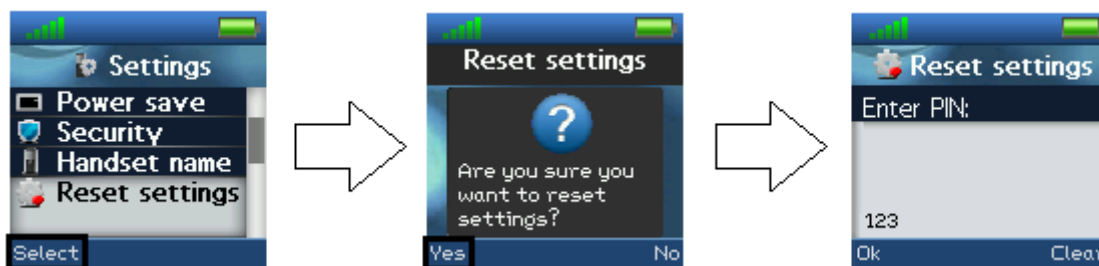

The handset PIN code is required to reset the handset. Following a reset the handset is still registered as the base is not also reset to default when selecting this feature.

### 6.5.8 Status

The menu “Status” delivers some useful information to the end user about the base station that the handset is currently using and the handset status.

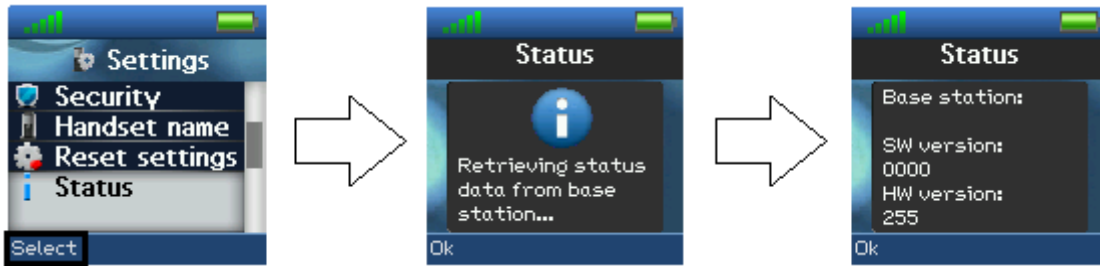

The displayed information is as follows.

Base station:

- Software version (the current software version of the base station)
- Hardware version (the hardware version of the base station)
- IP address (the IP address of the base station)
- MAC address (the MAC address of the base station)
- System name (the name of the system of base stations that the handset is registered to)

Handset status:

- Software version (the current software version of the handset)
- Hardware version (the hardware version of the handset)
- DECT band (the DECT band that the handset is using, e.g. EU or US)
- Battery level (the current battery level of the handset)
- IPEI (the IPEI/IPUI number of the handset is a static number identifying the specific handset)

## 6.5.9 Auto Answer

In this menu it is possible to change the settings for auto answer on the handset.



The “Auto answer” feature makes it possible for the handset to automatically answer an incoming call. This setting can be set to the following conditions:

**Normal**

With this enabled the handset does not answer a call automatically, but the user must always press the green “Off-hook” key to answer a call. The call is not answered by removing the handset from the charger.

**Any key**

In this mode pressing any key on the keypad (except the red “On-hook” key and the two softkeys that still have their normal functions) will answer an incoming call. The call is not answered by removing the handset from the charger.

**Automatic**

If the feature “Automatic” is enabled on the handset, then the incoming call is answered automatically after 5 seconds.

### 6.5.10 Silent Charging

The “Silent charging” feature can be used to disable ringing during charging. The options are as follows:



#### Off

The handset is ringing when receiving incoming calls (audio alert and incoming call screen displayed).

#### Silent

The handset receives an incoming call as normal, but it does not ring (i.e. no audio alert but the incoming call screen is displayed).

### 6.5.11 Do Not Disturb

This “Do not disturb” feature can be used when the handset user does not want to be disturbed.



With this feature disabled, the handset reacts as normal on all incoming activity. If the function is enabled, though, the handset will not react, and the calling counterpart will be directed to voice mail if this feature is enabled.

The “Do not disturb” icon  is displayed in the status bar when “Do not disturb” is enabled on the handset.

### 6.5.12 Hide Number

The “Hide Number” function enables that the user can make a call where the counterpart cannot see the caller ID of the caller.



#### Off

When the “Hide Number” function is set to “Off” with the left softkey, the caller ID of the handset is displayed to the counterpart of the call.

**On for next call**

If this function is enabled, the caller ID will be hidden for the counterpart only for the next outgoing call and displayed again for all following calls.

**Always on**

With “Always on” enabled, the caller ID will be hidden for the counterpart for all outgoing calls.

NOTE: When “Hide Number” is enabled, the base sends SIP header “Privacy: id” to address

sip:anonymous@anonymous.invalid

The PBX must support anonymous calls, otherwise the call is rejected.

**6.5.13 Call Forward**

The “Call Forward” feature enables the user to forward all incoming calls in different cases as described below.



**Forward Unconditionally**

If this feature is enabled, all incoming calls to the handset will be forwarded to the number setup in “Forward To” as seen below.

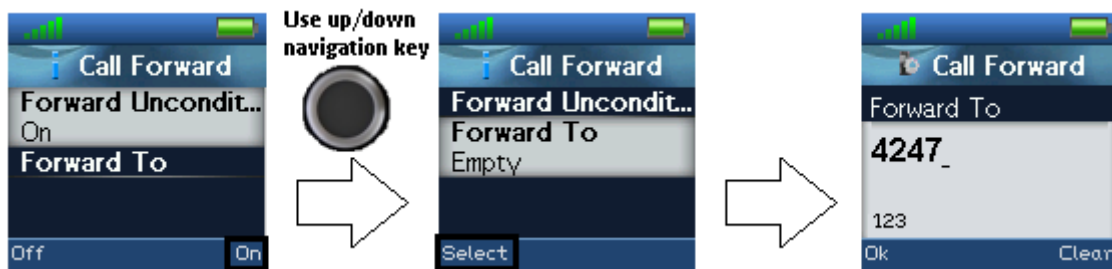

In this case the handset will not receive any incoming calls – all calls will automatically be forwarded to the number setup in “Forward To”.

**Forward No Answer**

By enabling “Forward No Answer”, an incoming call to the handset is forwarded if the call is not answered within a given time interval, for example 30 seconds. This feature is setup in the same way as “Forward Unconditionally” as displayed above.

**Forward Busy**

When “Forward Busy” is enabled, the handset forwards all incoming calls if the handset is busy, or if the user presses “Reject” on the call. This feature is also setup in the same way as “Forward Unconditionally” above.

**6.5.14 Idle Screen Saver**

When the idle screen saver is enabled, the handset screen will dim, but never turn off when the handset is placed in the charger.



The following three options can be selected for “Idle Screen Saver”:

Off

The screen will turn off completely after the power save timeout, even with the handset placed in the charger.

Idle clock (dimmed)

The handset will return to the idle screen and the screen will be dimmed after the power save timeout when the handset is placed in the charger.

Startup image (dimmed)

The screen will be dimmed and display the startup image after the power save timeout when the handset is placed in the charger.

### 6.5.14 Idle Clock

The “Idle Clock” function controls if the clock is showed in the idle display or not.



By selecting “Off” the idle clock will not be displayed in idle, and by selecting “On” the clock is displayed in idle.



## 6.6 Audio Settings

The “Audio Settings” menu is entered through the menu by pressing the selection key  in idle. It contains different settings for the sounds and ringing on the handset.



### 6.6.1 Silent Mode

The “Silent” profile can either be enabled with the right softkey “On” or disabled with the left softkey “Off”. When the “Silent” profile is enabled, no sounds are played on the handset and the handset does not ring on incoming calls or messages.



In the “Audio settings” menu no other settings can be entered when “Silent” is set to “On”.

### 6.6.2 Ring Volume and Ring Melody

When the handset receives an incoming call, different ring volumes and melodies can be selected.

#### Ring volume

The ring volume can be adjusted from mute to volume 6. The currently applied level is displayed when entering the menu “Ring volume”.

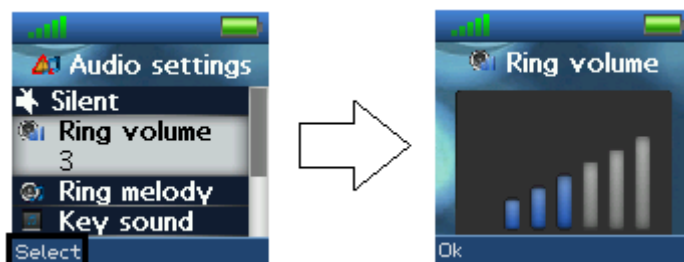

To select the desired ring volume, the navigation keys up/down or right/left are used to respectively increase or decrease the volume. Pressing “Ok” saves the current ring volume. The currently applied ring melody is played when adjusting the ring volume so that the respective ring volume can be heard before selected.

#### Ringer mute

The ringer is switched off when the lowest level is selected in “Ring volume”, and a mute image is showed in the display as seen below.

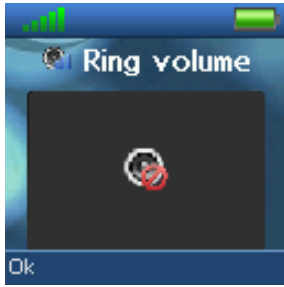

When the ring volume is set to mute, the “Sound off” icon is displayed in the status bar and no sound is heard when receiving an incoming call.

### Ring melody

Six different ring melodies can be chosen for the handset to play when receiving an incoming call. A list of melodies is displayed when entering the menu. Each displayed melody on the list can be selected by pressing the left softkey “Select”.



To hear the melody before selecting it, each melody in the list can be played by selecting the right softkey “Play”. The softkey “Play” changes to “Stop” during playback and the playback can then be stopped by pressing this button.

### 6.6.3 Key Sound

The “Key Sound” settings controls if a key sound is heard as the keys are pressed on the handset or if no sound is made. The following three options can be selected for the key sounds:



#### Silent

If this feature is chosen, there will not be heard any sounds when pressing the keys on handset.

#### Click

With this function enabled a click sound is heard when a key is pressed.

#### Tone

When this option is enabled a tone will be heard when a key is pressed.

**NOTE:** No key sound will be generated when pressing the keys during “key lock state” even though one of the options “Click” or “Tone” is enabled.

### 6.6.4 Confirmation Sound

This feature can either enable or disable confirmation sounds on the handset.

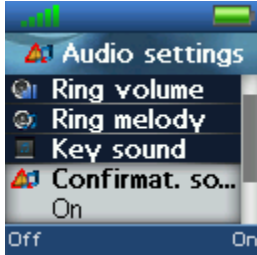

When the function “Confirmation sound” is enabled (On), an audible indication is given when an event succeeds or fails.

For example, a positive confirmation sound is generated when a new setting is set or an entry is saved successfully in the phonebook. A negative confirmation sound is generated if the action fails.

When the confirmation sound is set to “Off” no sounds is generated in either case.

### 6.6.5 Coverage Warning

A coverage warning can be set to occur when the handset is out of range of a base station in the system.

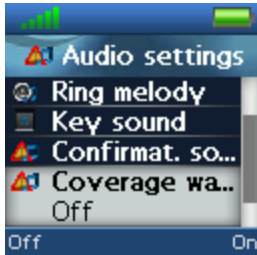

When the feature “Coverage warning” is enabled (On), an audible indication is given in the earpiece of the handset when the user is close to the maximum range of the nearest base station in the system. This way the user will know that the call is at the edge of the possible coverage of the call and that the user has to move back in coverage to keep the call going.

**NOTE:** This feature is only working when the handset is in call, not when in idle.

### 6.6.6 Charger Warning

“Charger Warning” is a feature that enables the handset to make a sound when put in the charger to indicate that the handset is charging.

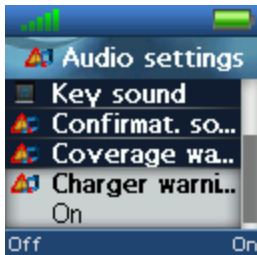

When the feature “Charger warning” is enabled (On), an audible indication will be given when the handset is correctly connected to the charger.

If the feature is set to “Off”, no audible indication will be given as the handset is put in the charger.

## 7 Calls Operations

In this section the different types of calls and call handling will be described.

### 7.1 Incoming call

As the handset receives an incoming call an alerting screen will be displayed as displayed below. A ring signal will accompany this according to the respective settings on the handset.

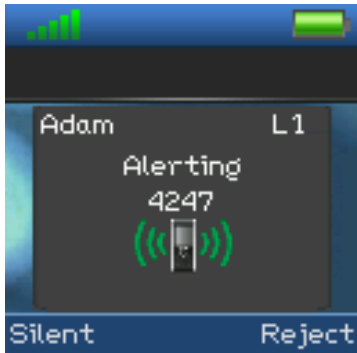

The calling party's handset number will be shown in the display, and an additional name is displayed if the calling party's handset number is stored in the local phonebook.

#### 7.1.1 Answering an Incoming Call

To answer an incoming call, press the green "Off-hook" button  , or press the "Off-hook" button two times to change to speaker mode.

**NOTE:** When "Auto answer" is set to "Automatic" an incoming call is answered automatically after one ring signal. If "Auto answer" is set to "Any key" an incoming call can be answered by pressing any key on the keypad, and not just the green "Off-hook" button.

#### 7.1.2 Reject an Incoming Call

It is possible to reject an incoming call by pressing the right softkey "Reject" when receiving an incoming call. This way the calling party will receive a busy tone, and "User busy" displayed on the screen as shown in the picture below.

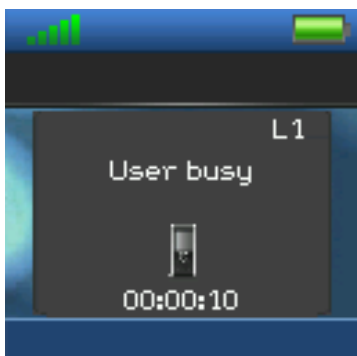

**NOTE:** An incoming call can also be rejected by pressing the red "On-hook" key.

#### 7.1.3 Silencing an Incoming Call

When the handset is alerting it is possible to press the left softkey "Silent". The handset will continue to alert, but without any audible ringing.

## 7.1.4 Ending a Call

To end an ongoing call, press the red “On-hook” key  , and the call will be terminated. The duration of the call is shown in the display. Furthermore, this duration time can also be viewed from the call list where the call is stored.

**NOTE:** If one call is active and another call is on hold, then the active call will be terminated when pressing the red “On-hook” button and the handset automatically returns to the call on hold. The call on hold is now active and the user has to press the red “On-hook” button again to terminate this call.

## 7.2 Initiating a Call

A call can be initiated from different locations on the handset:

- By entering the number directly from idle
- From the “Contacts” menu
- From the “Calls” menu
- From the “Central Directory”

How to initiate a call from these different directories is explained in the following sub sections.

### 7.2.1 Initiating a Call from Idle

When initiating a call from idle it must be done according to the following:

1. Enter the number of the person you want to call when the handset is in idle.
2. Press the green “Off-hook” button  to call the number.



3. The handset will show a “Calling” screen as seen above.
4. When the counterpart answers the call the screen will show “Connected” and the two parts are now in call.

#### 7.2.1.1 Line Call

If the handset is used in a multiline environment, it is possible to make a call from different lines. The line must be predefined via the settings menu. Refer to the settings section of this guide.

**NOTE:** To see additional information on the “Line” function, please check the base system document via [2].

### 7.2.2 Initiating a Call from Contacts

To initiate a call from the contact list, there must be contacts added to the local phonebook. When this prerequisite is met a local contact can be called by highlighting the contact in the contact list and then pressing the green “Off-hook” button.

**NOTE:** The list of local contacts can be reached from the menu “Contacts” or directly from idle by pressing the left softkey when in idle.

### 7.2.3 Initiating a Call from Calls

The number of an outgoing, incoming, or missed call can be called directly from the call list by highlighting the number and pressing the green “Off-hook” button to call the entry.

**NOTE:** The “Calls” list can be reached from the menu “Calls” or directly from idle by pressing the green “Off-hook” button.

## 7.2.4 Initiating a Call from the Central Directory

When opening the “Central directory” a call can be made to a specific contact by searching for this contact, and thereby enter the list from which a contact can be called by pressing the green “Off-hook” key.

If different numbers are assigned to one contact a green arrow is showed to the right of the contact, and the right/left navigation keys can be used to choose which number that should be called.

**NOTE:** The “Central Directory” can be reached both from the menu “Central Directory” or directly from the idle by pressing the right softkey when in idle.

## 7.3 Call Holding/Retrieving

It is possible to hold a call which means that the one party of the call is put on hold and cannot hear the other party, but can only hear a repeated short tone on hold until the call is retrieved.

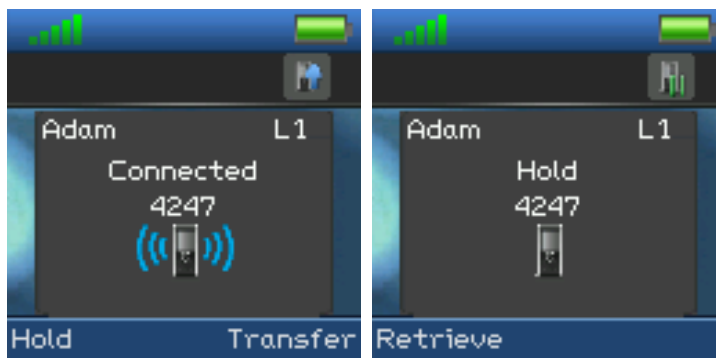

1. To put the counterpart of the call on hold press the left softkey “Hold” and this party is put on hold.
2. To retrieve the call, and thereby continue the conversation, press left softkey “Retrieve” which is only showed on the screen when the other party of the call is put on hold.

**NOTE 1:** If one call is active and another call is on hold, then the active call will be terminated when pressing the red “On-hook” button, and the handsets automatically returns to the call on hold, i.e. the call on hold is now active, and the user must press the red “On-hook” button again to terminate this call.

**NOTE 2:** When the counterpart is put on hold it is also possible establish a second call and make a conference, swap or transfer which will be explained in the following sections.

## 7.4 Attended and Unattended Transfer of a Call

When in an ongoing call, it is possible for either party to transfer the call, either attended or unattended, to another handset.

### 7.4.1 Attended Transfer

In an attended transfer the party that call is transferred to, is called before the transfer is made. The procedure to do this is as follows.

1. Initiate a call with a counterpart so that the handset displays “Connected” as shown below.



2. Press the right softkey “Transfer” on either of the handsets in call. The counterpart of the call is put on hold.
3. Enter the number that the transfer should be made to and press the green “Off-hook” button 
- 4.

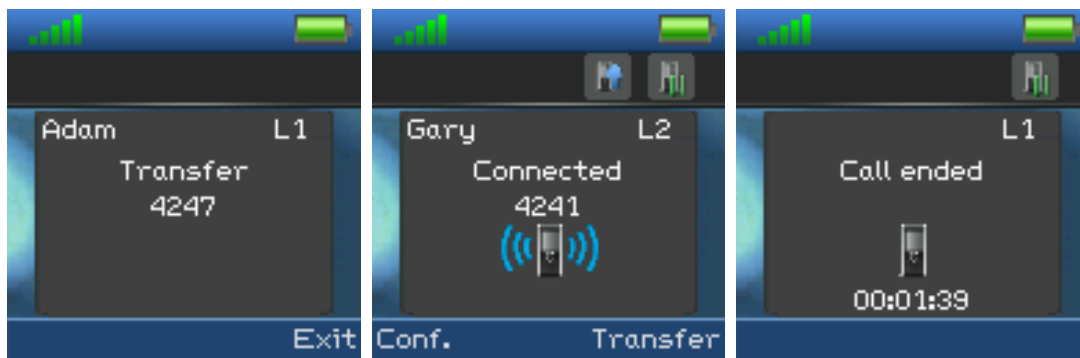

5. A ring back tone is heard, and the third party is called.
6. As the third party answers the call, the handset initiating the transfer will show a connected screen as seen above.
7. To make the transfer after the third party has answered the call, press the right softkey “Transfer”. The call is transferred so that the second and third party are now in call and a “Call ended” screen is displayed on the handset that initiated the transfer as seen above.

**NOTE:** It is also possible to make an attended transfer by pressing either the left softkey “Hold” instead of pressing the right softkey “Transfer” in step 2.

## 7.4.2 Unattended Transfer

When making an unattended transfer, the call will be transferred directly to a third party without the party initiating the transfer needing to call this third party before the transfer.



1. Initiate a call with a counterpart so that the handset displays “Connected” as shown above.
2. Press the right softkey “Transfer” on either of the handsets in call, and the counterpart of the call is put on hold.

3. Enter the number that the transfer should be made to, and press transfer.
4. This will end the call on the first handset party (screen showing “Call ended”), and the second party will stop being on hold and hear a ring back tone instead which indicates that this handset is now calling the third party.
5. When the third party answers the call, an unattended transfer has been made and the second and third party are now in call.

**NOTE:** As with attended transfer, it is also possible to make an unattended transfer by pressing the left softkey “Hold” instead of pressing the right softkey “Transfer” in step 2.

## 7.5 Swap between Two Calls

It is possible to swap between two calls. In this case, one party will be in ongoing call, and the second party will be on hold. So “Swap” means that it is possible to toggle between these two parties.



1. Initiate a call with a counterpart so that the handset displays “Connected” as shown above.
2. Put this call on hold by pressing the left softkey “Hold”.
3. Enter the number of a second party, and press the green “Off-hook” button.
4. A ring back tone is now heard in the handset as the second party is alerting.

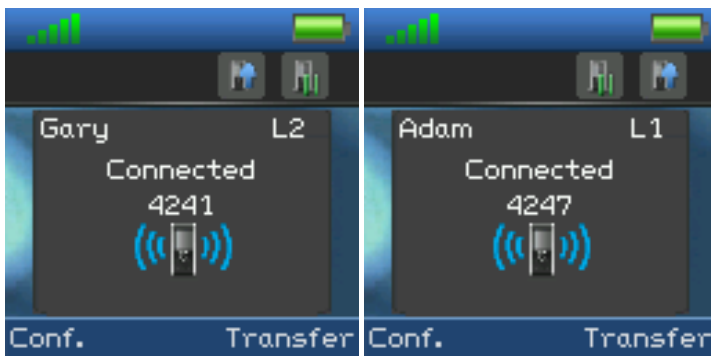

5. As the second party answers the call a blue “Connected” screen as above is displayed.
6. By pressing the right navigation key , the two calls are swapped which means that the ongoing call is now between the first party with the second party now put on hold.
7. From this point, it is possible to toggle between the two parties by pressing the right navigation key. For each time that the right navigation key is pressed a toggle is made between the two external parties, and the small handset icons in the right top corner of the display and either “L1” or “L2” shows if the handset is connected to the first or the second party.



## 7.6 Call Waiting

When two parties are in call it is possible to receive a call waiting on one of the handsets which means that a third party calls one of the two parties already in a call. During a call waiting, two short beeps are heard every three seconds in the handset receiving the call waiting and the following screen is displayed:

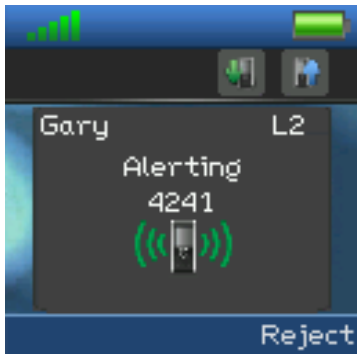

In this case the call waiting is from party 4241 (called Gary in the local phonebook). It is possible to reject the call waiting with the right softkey "Reject" and continue the ongoing call. If the call party wants to answer the call waiting the off-hook key should be pressed. The following screen is displayed:

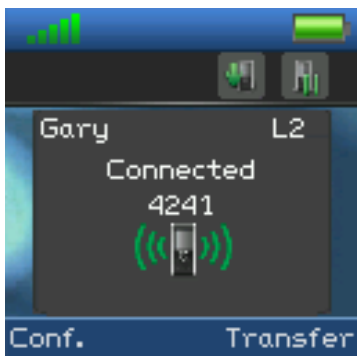

This indicates that the local handset now has two ongoing calls with one of them on hold, and it is possible to swap between them, make a conference, or transfer one of the parties.

## 7.7 Conference Call

In a conference call there are always at least three parties in the same conversation. This feature enables the user to have an ongoing call with more than one person at the same time. The parties in a conference call are called participants.

### 7.7.1 Establishing a Conference Call

In the following it is described how to establish a conference call between three parties.



1. Initiate a call with a counterpart so that the handset displays “Connected” as shown above.
2. Press the left softkey “Hold” to put the ongoing call on hold.
3. The second party is put on hold and will hear a tone on hold.
4. Enter the number of the party to invite to the conference and press the green “Off-hook” button  to call this participant.

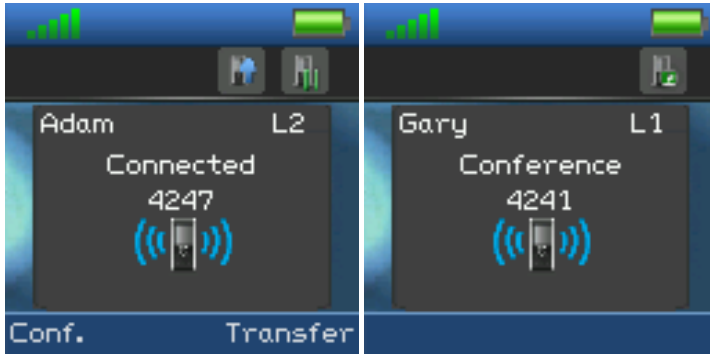

5. When the called party answers the call, the second party is still on hold and the conversation is only between the third party and the first party, i.e. initiator of the conference.
6. To start conversation between the three parties – i.e. a conference – press the left softkey “Conf.”
7. The “Conference” screen as seen above will then be displayed and the three participants will be in a conference call. Thereby the conversation is between all three parties.

**NOTE 1:** It is possible to invite more participants to the conference by repeating the steps 2-6 for one of the participants in the conference that has not yet invited a party to the conference. Once a participant has invited a new party to the conference it is not possible for this participant to invite new parties to the conference.

**NOTE 2:** The maximal number of participants to participate in a conference call is set according to the number of bases in a system. In a system with two bases it should be possible to have 10 participants in a conference call.

## 7.7.2 Terminating a Conference Call

When a conference call is terminated it is dependent of which participant that terminates it, if the whole conference is terminated, or if the conference is ongoing between the two participants left in the conference.

Option 1

1. The user who has started the conference presses the red “On-hook” key  to terminate the conference call.
2. The whole conference is terminated, and none of the participants continues to be in call.

Option 2

1. One of the participants that have been invited to the conference presses the red “On-hook” key  to terminate the conference call.
2. The call is only terminated for the participant that terminated the call
3. There is still an ongoing call between the initiator of conference, and the participant that have not ended the call.

**NOTE:** Different configurations on the PBX that the base system uses may result in different terminations of a conference call. For instance, the configuration of some PBX’s could cause that the whole conference call is not terminated if the initiator of the conference presses the red “On-hook” key to terminate.





## 8 Accessories

It is possible to get different accessories to the RTX SME VoIP 8430 handset:

- Battery
- Battery Cover

## 9 Troubleshooting

This troubleshooting section contains information on how to solve some operational problems that you may experience on the handset.

### 9.1 Operational problems

**State: *The handset does not ring***

**Problem cause:** The sound off icon is seen in the status bar; hence the handset is silent mode.

**Action:** Increase the volume in Audio Settings, or long-press the #-key in idle.

**NOTE:** If the Audio Settings is greyed out and cannot be changed, it is because the silent mode is enabled by long-pressing the #-key. Please, long-press the #-key in idle to disable this silent mode.

**State: *The handset does not respond when pressing on the keys***

**Problem cause:** The keylock is enabled, and a “Press and hold \*” screen is displayed when pressing any key.

**Action:** Long-press (press for more than 2 seconds) the \*-key.

**State: *The handset shows “Searching” in the display***

**Problem cause:** The handset is out of the coverage area of the base station system.

**Action:** Please move the handset back in coverage of the base system.