



# snom<sup>®</sup> PA1 User Manual

## TABLE OF CONTENTS

<b>Copyright, Trademarks, GPL, Legal Disclaimers</b> .....	<b>4</b>
<b>Important information</b> .....	<b>5</b>
Safety instructions .....	5
SELV (Safety Extra Low Voltage) compliance .....	5
Standards conformance .....	6
Disposal of the device .....	6
Cleaning .....	6
<b>Standard feature list</b> .....	<b>7</b>
<b>Setting up the snom PA1</b> .....	<b>8</b>
Delivery Content .....	8
Wallmounting .....	8
Connecting the PA1 .....	9
<b>Initializing and Configuring the PA</b> .....	<b>10</b>
Initializing .....	11
Initializing with DHCP .....	11
Initializing without DHCP .....	11
Security settings .....	13
Configuring accounts .....	15
Configuring identities automatically .....	15
Configuring identities manually .....	15
Settings .....	16
Time Zone .....	16
Setting Tone Scheme .....	16
Automatic termination of calls .....	17
Adjusting volume and amplifier gain .....	17
<b>Using the snom PA1</b> .....	<b>18</b>
Making announcements .....	18
Turning the loudspeaker on or off .....	18
<b>Software update</b> .....	<b>19</b>
Provisioning software updates .....	19
Manual software update .....	20
Setting .....	20
Updating manually .....	20

<b>Troubleshooting</b> .....	<b>23</b>
Reboot .....	23
Hard reboot .....	23
Reset to factory values .....	24
Contacting snom Support .....	24
Traces .....	25
<b>Appendix 1</b> - Drilling Template PA1 Wallmounting .....	<b>26</b>
<b>Appendix 2</b> - GNU General Public License .....	<b>27</b>

# Copyright, Trademarks, GPL, Legal Disclaimers

© 2013 snom technology Aktiengesellschaft

All Rights Reserved.

snom, the names of snom products, and snom logos are trademarks owned by snom technology AG. All other product names and names of enterprises are the property of their respective owners.

Product specifications are subject to change without notice.

snom technology AG reserves the right to revise and change this document at any time, without being obliged to announce such revisions or changes beforehand or after the fact.

Texts, images, and illustrations and their arrangement in this document are subject to the protection of copyrights and other legal rights worldwide. Their use, reproduction, and transmittal to third parties without express written permission may result in legal proceedings in the criminal courts as well as civil courts.

When this document is made available on snom's web page, snom technology AG gives its permission to download and print copies of its content for the intended purpose of using it as a manual. No parts of this document may be altered, modified or used for commercial purposes without the express written consent of snom technology AG.

Although due care has been taken in the compilation and presentation of the information in this document, the data upon which it is based may have changed in the meantime. snom therefore disclaims all warranties and liability for the accurateness, completeness, and currentness of the information published, except in the case of intention or gross negligence on the part of snom or where liability arises due to binding legal provisions.

Our firmware includes some source code that may be used and modified by anyone and everyone under the GNU Public License (GPL) (enclosed in the appendix), provided they, in turn, make it available to everyone else with the same licensing agreement. Please go to <http://www.snom.com/en/support/download/gpl-open-source/> for the original GPL license and the source code of components licensed under GPL and used in snom products.

## Important information

Please read the instructions on safety and disposal and on how to set up and use the device before using it and also give them to other users to read or inform those users of their contents. Save this manual and do not give the device to third parties without it.

## Safety instructions

Follow the instructions in this manual and other applicable documentation of the device.

- If the device is not supplied with power via an Ethernet cable, use only a power adapter expressly recommended by snom technology. Other power supplies may damage or destroy the device, affect its behavior, or induce noise.
- Avoid placing the cables where people may trip over them or where they may be exposed to mechanical pressure as this may damage them.
- This device is for indoor use only! **NOT FOR OUTDOOR USE!**
- Do not install the device in rooms with high humidity (for example, in bathrooms, laundry rooms, damp basements). Do not immerse the device in water and do not spill or pour liquids of any kind onto or into the device.
- Do not install the device in surroundings at risk for explosions (paint shops, for example). Do not use the device if you smell gas or other potentially explosive fumes.
- Do not use the device during thunderstorms. Lightning striking the power grid may cause electric shocks.
- **Do NOT** remove the device's power supply (Ethernet cable when using PoE, power adapter when not using PoE) when the red light is on or blinking; a firmware update is ongoing. Cutting off the device's power during a firmware update (red LED on, green LED off) will damage the firmware and render the PA1 inoperational. In such cases, it will need to be returned to the vendor for resetting.

## SELV (Safety Extra Low Voltage) compliance

Safety status of Input/Output connections comply with SELV requirements.

**Warning:** To avoid electric shock, do not connect safety extra-low voltage (SELV) circuits to telephone-network voltage (TNV) circuits. LAN ports contain SELV circuits, and PSTN ports contain TNV circuits. Some LAN and PSTN ports both use RJ-45 (8P8C) connectors. Use caution when connecting cables.

## Standards conformance



This device complies with the essential health, safety, and environmental requirements of all relevant European directives. The declaration of conformity can be requested from snom (address see reverse cover).



This phone is FCC-certified and meets US health, safety, and environmental standards.

Unauthorized opening, changing, or modifying the device will cause the warranty to lapse and may also result in the loss of CE conformity and the FCC certification. In case of malfunction contact authorized service personnel, your seller, or snom.

## Disposal of the device



This device is subject to European Directive 2002/96/EC and may not be disposed of with general household garbage.

The separate collection and proper disposal of electrical and electronic devices serve to protect human health and the environment as well as to use and reuse resources prudently and rationally.

If you do not know where you may dispose of the device at the end of its lifespan, contact your municipality, your local waste management provider, or your seller.

## Cleaning

To clean the device, use an anti-static cloth. Please avoid cleaning liquids as they might damage the surface or internal electronics of the device.

# Standard feature list

- IEEE 802.3af PoE compliant, Class 3
- 2 port 10/100Mb Ethernet switch
- SIP or multicast support
- Remote SW update
- Network/web management
- Remotely settable speaker volume adjustment
- Push-on speaker terminals
- Class D 4W power amplifier (loudspeaker not included)
- IP address/reset button
- Call/network activity indicator
- One "MIC in" and one "LINE out" 3.5 mm connector for headset connection (SPK impedance = 150 Ohm, MIC power supply 3.3V, RL = 2 KOhm, S= -42 dB (+-2dB)). Microphone input must be differential and without grounding. This port is **for installation and maintenance purposes only**, not for the connection of other devices.
- 4 I/O pins remotely settable
  - via web interface (in administrator mode only) or
  - with DTMF tones (with programmable timer)
- Robust casing design for wall mounting

## Not included:

- 5V power adapter PSAC10R-050 (available separately - snom PN 00002730)
- Loudspeaker
- Keyboard
- Network cable

# Setting up the snom PA1

## Delivery Content

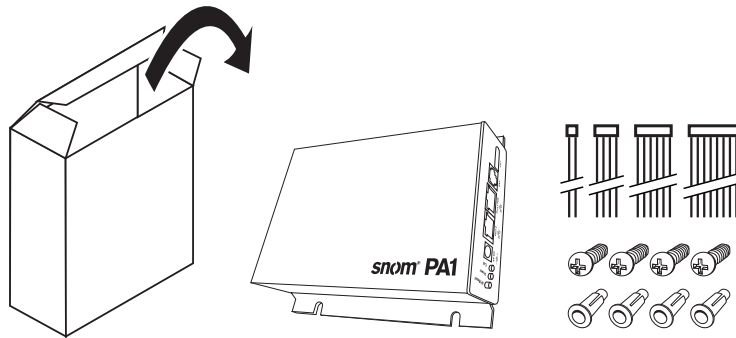

- Base unit
- 2 brackets for wall mounting (pre-assembled)
- 4 screws (Ø 8 mm, length 16 mm) + 4 expansion anchors for wall mounting
- Cable set (4 proprietary snom cables for connecting periphery devices)
- Quick Start Guide

## Wallmounting

**Note:** The Ethernet cable must not be bent to avoid damage and loss of the network connection. We recommend that you place the PA1 so that the PoE connector is facing toward the LAN port in your network. We also recommend that you place the PA1 in a location where you can see the LEDs from your desk or work station.

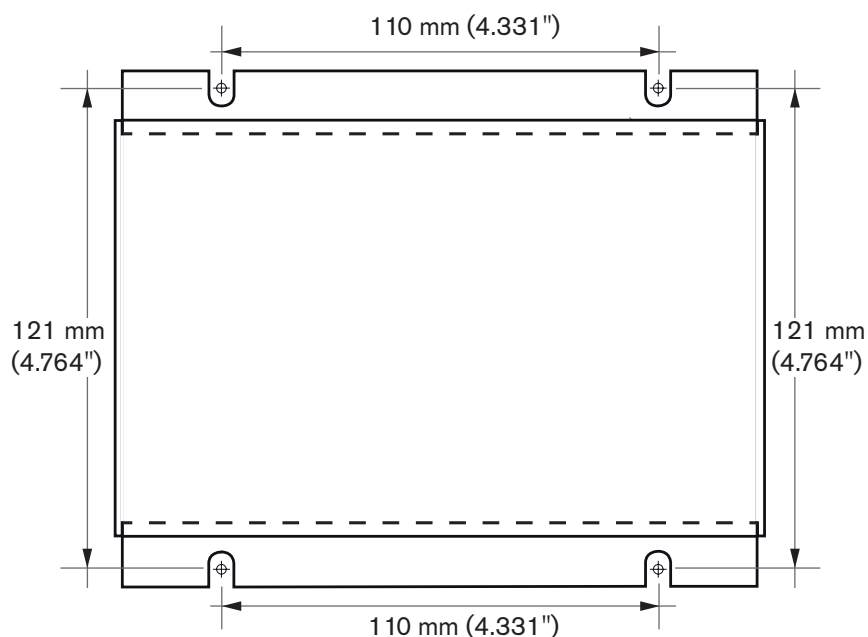

Fig. 1



1. Use the measurements in Fig. 1 to mark the positions of the four holes to be drilled in the wall, or use the template at Appendix 1.
2. Drill the holes and insert the expansion anchors in the holes.
3. Place the snom PA1 on the wall with the cut-outs above the anchors as shown in Fig. 2.

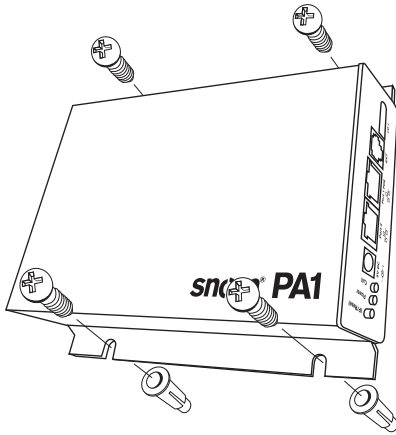

Fig. 2

4. Place the screws in the anchors and tighten them evenly..

## Connecting the PA1

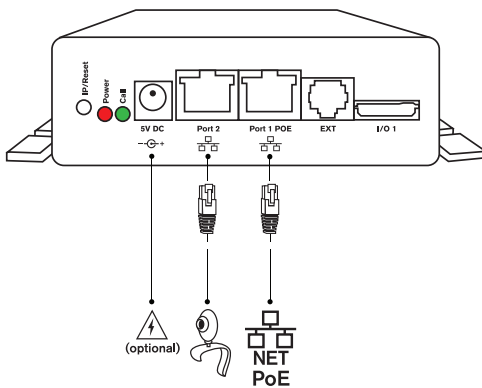

Fig. 1

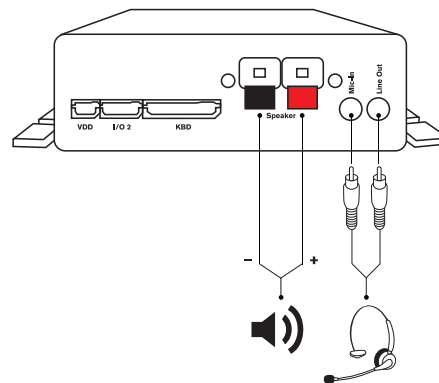

Fig 2

1. Plug the Ethernet cable into the RJ45 connector labelled "Port 1PoE", as shown in Fig. 1. The second RJ45 connector labelled "Port 2" is for daisy-chaining further Ethernet devices without the need for another Ethernet cable.

**If no PoE available:** Connect a snom-approved 5 V 10 W power adapter to the power connector labelled "5V DC".

2. Connect the loudspeaker wires to the speaker terminals labelled "Speaker", as shown in Fig. 2. Connect the "+" wire with the red terminal, connect the "-" wire with the black terminal.

**Note:** If you want to use a headset during the setup:

- Connect the headset's microphone plug to the jack labelled "Mic-In".
- Connect the headset's speaker plug to the jack labelled "Line-Out".

# Initializing and Configuring the PA

## Status of PA1

### During setup

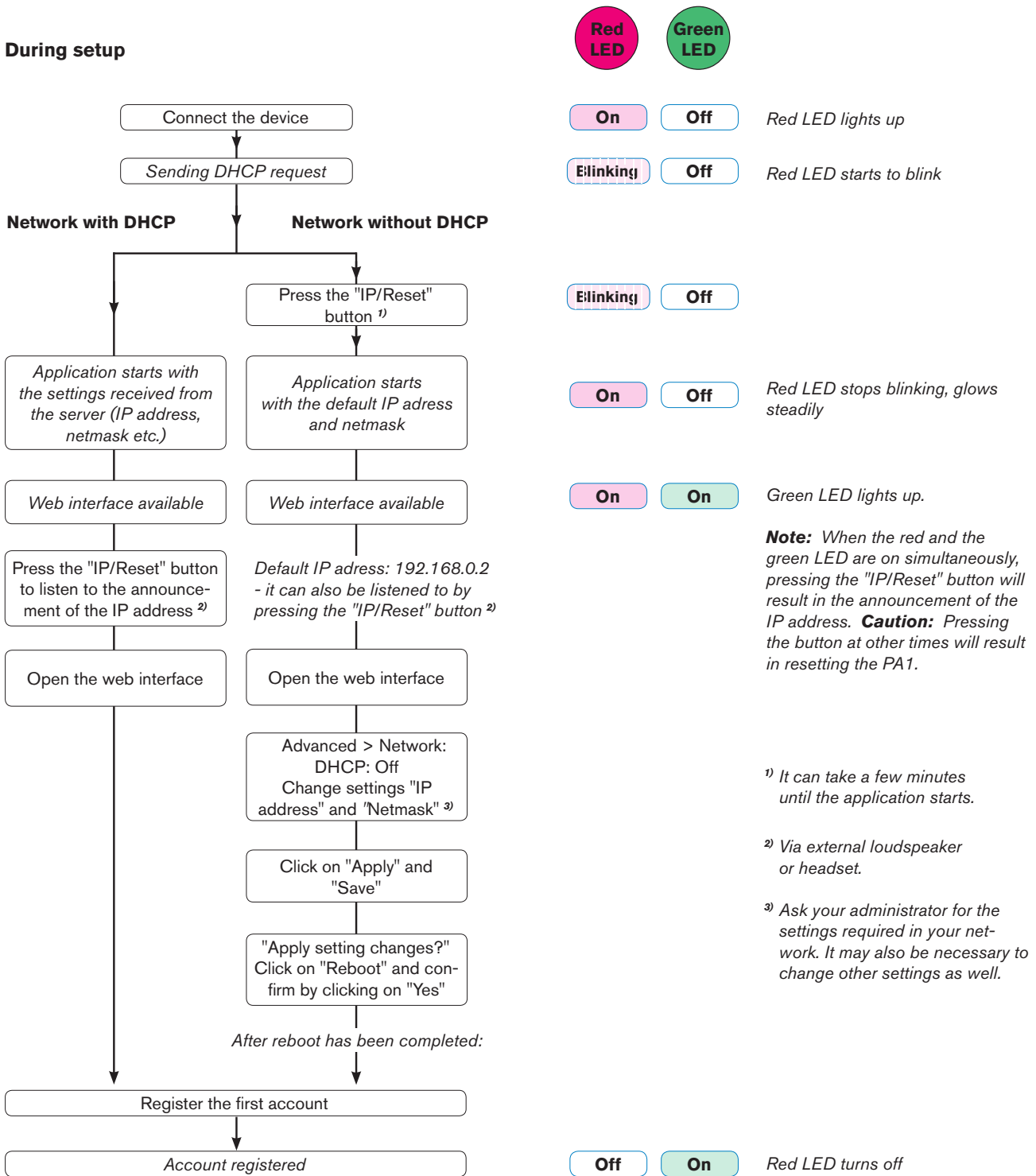

### LED indications when application is running

Ready	Off	On
Busy	Off	Blinking
Firmware update in progress	On	Off

## Initializing

After the PA1 has been connected to the network via Ethernet cable, the red LED marked "Power" will light up. The PA1 begins to boot.

### Initializing with DHCP

The snom PA1 has a built-in DHCP client. When DHCP is available in the network, the PA1 will initialize automatically.

1. The red LED begins to blink. The PA1 is sending the DHCP request.
2. After the PA1 has received an IP address and other network-related settings (netmask, IP gateway, DNS server, etc.) from the DHCP server, the red LED stops blinking and glows red steadily, indicating that the application is starting up.
3. When the PA1 boot up process is finished and the web interface is available, the green LED lights up in addition to the red one.
4. Briefly press the button labelled "IP/Reset" to listen to the oral announcement of the IP address (in English) over the loudspeaker or headset.
5. Open a web browser on a PC connected to the same network as the PA1.
6. Type the IP address into the address bar after http:// and press "Enter" to open the PA1's web interface.
7. Continue with "Security settings" on page 13.

### Initializing without DHCP

If your network does not support DHCP, the snom PA1 will boot with the default settings. Please obtain the network IP address and netmask and, if applicable, other required network settings from your network administrator. The default settings are:

IP address: 192.168.0.2  
Netmask: 255.255.0.0

1. The red LED begins to blink. The PA1 is sending the DHCP request.
2. Press the button labelled "IP/Reset". The red LED continues to blink.  
**Note:** It may take a few minutes before the PA1 aborts the DHCP request and starts the application with the default settings.
3. When the application is starting up with the default network settings, the red LED stops to blink and glows red steadily.
4. When the PA1 boot up process is finished and the web interface is available, the green LED lights up in addition to the red one. You can now change the default settings manually.  
**Note:** Briefly press the button labelled "IP/Reset" to listen to the oral announcement of the default IP address (in English) over the loudspeaker or headset.
5. Open a browser on a computer connected to the same network as the PA1, and type the default IP address in the address bar: http://192.168.0.2. The PA1 web interface will be loaded into the browser.

6. Click on "Advanced" in the menu on the left side of the window. The "Advanced" page opens to the "Network" tab.

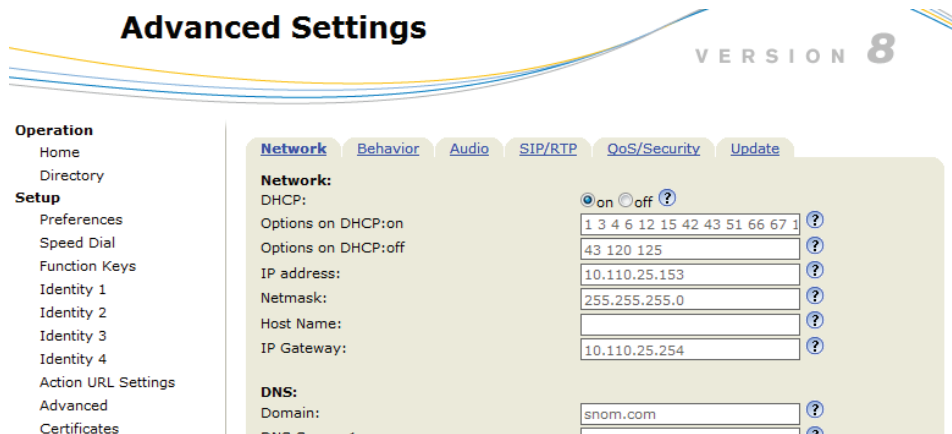

7. In the "Network" section make the following changes:
  - a. "DHCP" setting: Click on "Off".
  - b. "IP address" and "Netmask" settings: Replace default values with network values.
  - c. Other settings: Replace if and as required.
8. Click on the "Apply" button at the bottom of the page
 

**Note:** Any changes you make will not take effect until you click on "Apply". Changes will be lost if you open another page of the web interface or if you close the web interface without first clicking on "Apply".

9. After you have clicked on "Apply", three buttons will appear at the top of the page.

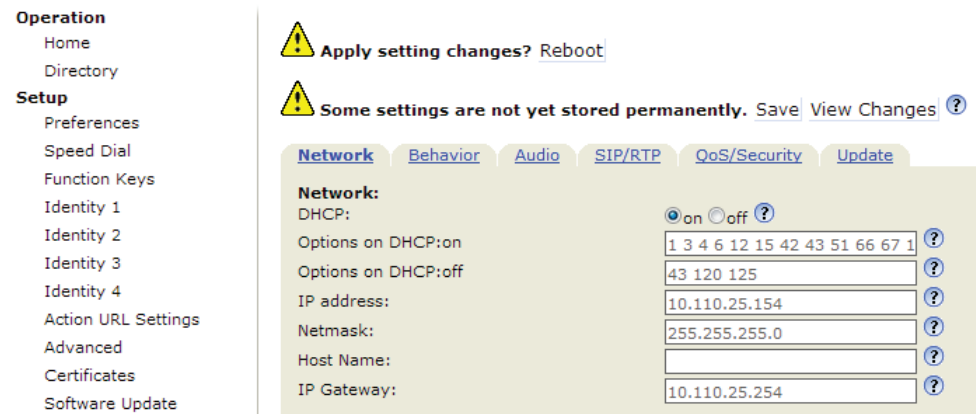

- a. Click on the "Save" button to save the changes permanently.
 

**Note:** Changes that have not been saved will be lost if and when the phone loses power or is disconnected from its power source.

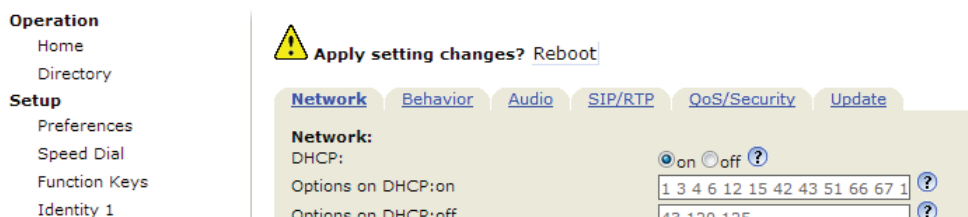

- b. Click on the "Reboot" button. The **Confirmation** page will appear.

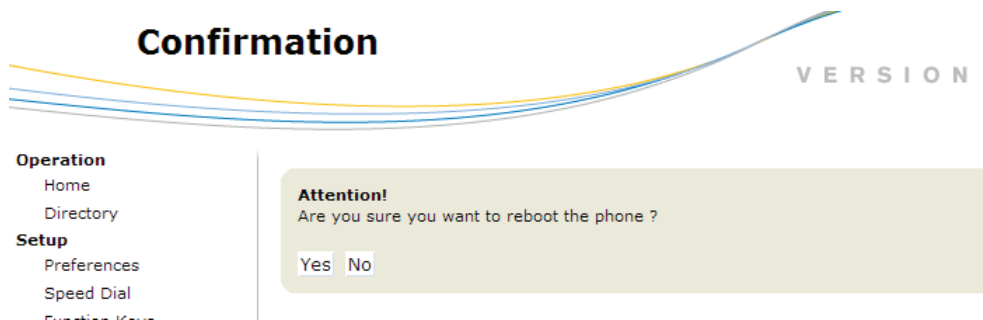

- c. Click on "Yes". The PA1 will save the new settings and restart. When the start-up with the network settings is complete, the red and the green LED will both be glowing steadily.

10. Continue with "Security settings".

## Security settings

When the web interface is opened for the first time upon initialization, you will see the Security page.

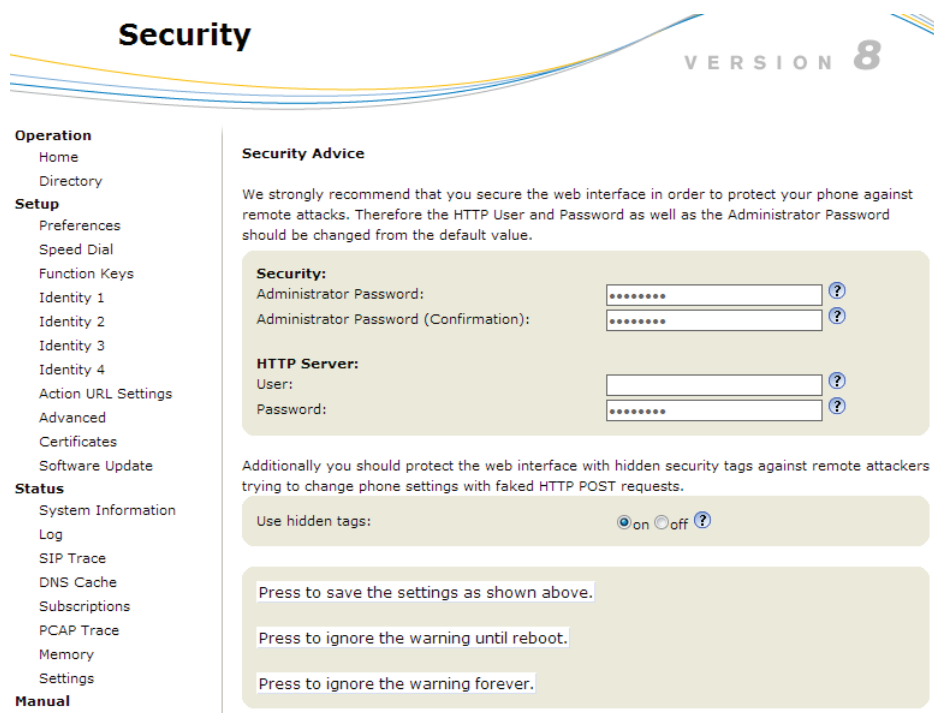

### Firmware versions below 8.7.4

We urge you to set administrator and HTTP passwords to protect the PA1 from remote attacks. The default administrator password is 0000 (4 zeros); there is no default HTTP password.

**Note:**

- If you do not replace the default administrator password by an individual one, an unauthorized third party could set an administrator password unknown to you. In such a case, you would no longer be able to switch from user mode to administrator mode. Unauthorized third parties would also be able to set the device back to factory values.

- If you do not set an HTTP password, you make it easier for third parties to break into your system.
- If you set your own passwords, be sure to write them down and store them in a secure place.

Without the administrator password, you will not be able to switch the web interface from user mode to administrator mode; the settings will be inaccessible.

Without HTTP password you cannot open the PA1's web interface.

If you do not wish to set an HTTP password, click on the respective button to turn off the reminder until the next reboot or permanently. If you change your mind later, you can set the password on the PA1's web interface, "Advanced"page > "QoS Security" tab > "HTTP Server" or turn off the warning later at Advanced > QoS Security > Security > Ignore security advices.

Continue with "Configuring accounts" on page 15.

### **Firmware versions 8.7.4 and higher**

When you register the first account, the SIP user name and password will be registered as the HTTP user name and password. If you wish to change them later, you can do so on the PA1's web interface > Advanced > QoS Security > HTTP Server.

#### **Note:**

- If you do not replace the default administrator password by an individual one, an unauthorized third party could set an administrator password unknown to you. In such a case, you would no longer be able to switch from user mode to administrator mode.
- If you set your own passwords, be sure to write them down and store them in a secure place.

Without the administrator password, you will not be able to switch the web interface from user mode to administrator mode; the settings will be inaccessible.

Without HTTP password you cannot open the web interface.

Continue with "Configuring accounts" on page 15.

## Configuring accounts

The PA1 supports up to four accounts (or identities, as they are called on snom devices) that can be used to make announcements over the loudspeaker connected to the PA1.

### Configuring identities automatically

(recommended) by using the provisioning server. For more details on auto provisioning snom devices see [www.snom.com/wiki](http://www.snom.com/wiki).

### Configuring identities manually

In the menu on the left, click on "Identity 1". The page "Configuration Identity 1" opens with the "Login" tab active.

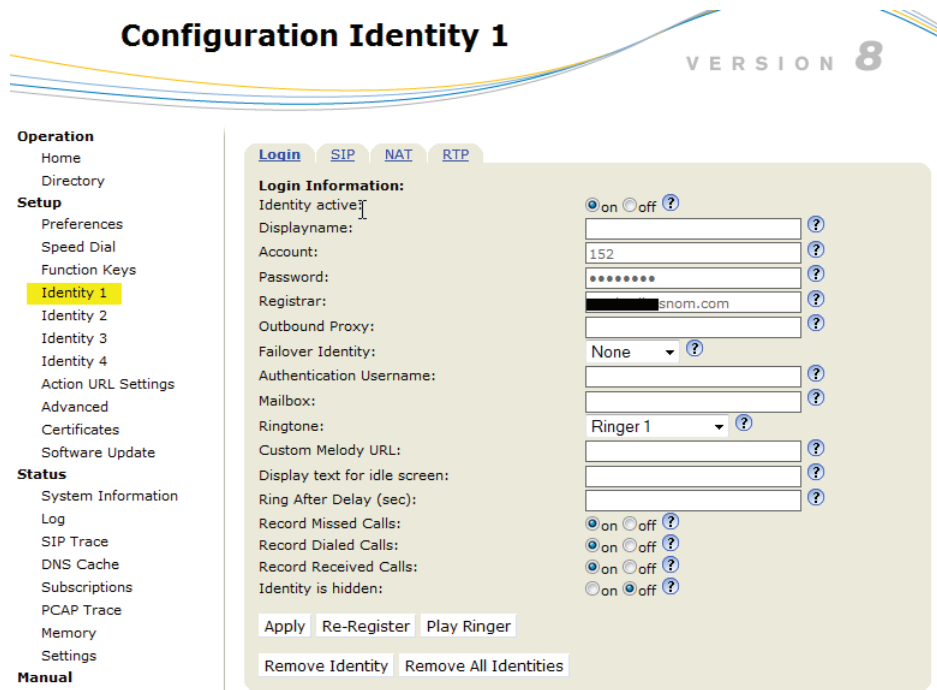

1. Enter the data required by your network in the text fields:
  - Account: Name/phone number.
  - Password: Password for your account, if necessary.
  - Registrar: Registrar address of your PBX software.
2. Click on "Apply" or "Re-Register". The "Save" button appears at the top of the page.

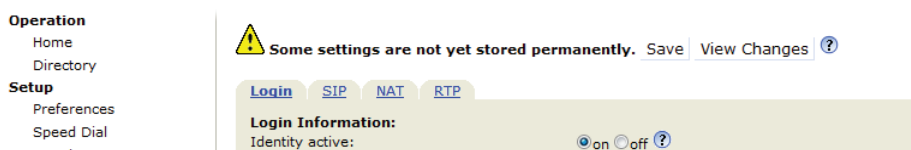

3. Click on "Save" to save the changes permanently. Changes that have not been saved will be lost if and when the phone loses power or is disconnected from its power source.

If the registration has been successful, the red "Power" LED will turn off. The green "Call" LED will stay on, indicating that the snom PA1 is ready to receive announcements.

# Settings

Normally, it is only necessary to set the time zone and the tone scheme. You can adjust the default settings for loudspeaker volume, amplifier gain, and automatically ending calls, as necessary or desired.

## Time Zone

1. Open the PA1's web interface.
2. Click on **Advanced** in the menu on the left side of the window page. The "Advanced Settings" page opens to the "Network" tab.

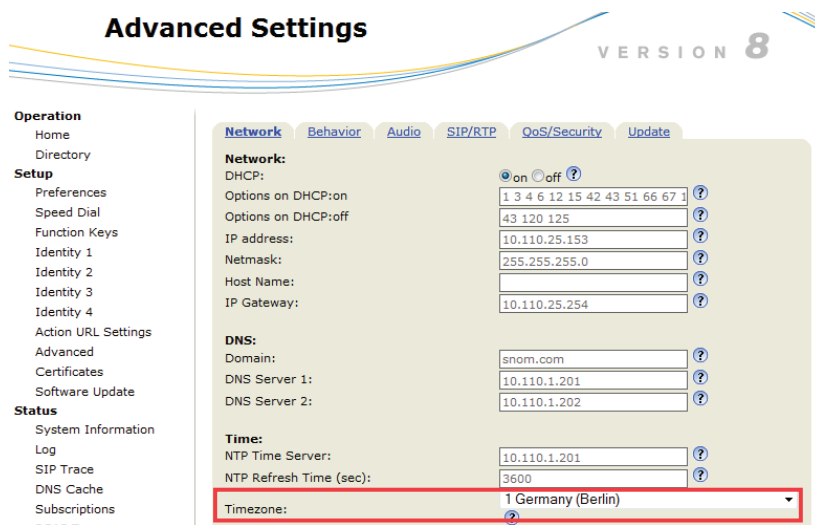

3. In the **Time** section select your time zone (i.e., country/city) from the drop-down menu of **Timezone**.
4. Click on "Apply" at the bottom of the page.
5. After clicking on "Apply", the "Save" button will appear at the top of the page. Click on "Save" to save the changes permanently in case of power loss.

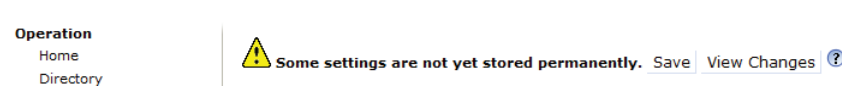

## Setting Tone Scheme

1. Open the PA1's web interface.
2. Click on **Preferences** in the menu on the left side of the window page. The "Preferences" page opens.

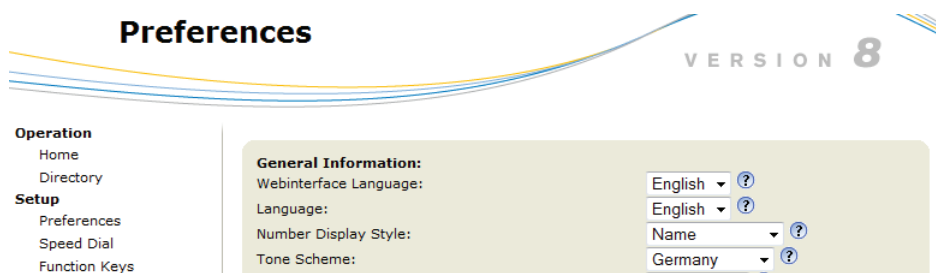



3. In the **General Information** section select your country from the drop-down list of **Tone Scheme**.
4. Click on "Apply" at the bottom of the page.
5. After clicking on "Apply", the "Save" button will appear at the top of the page. Click on "Save" to save the changes permanently in case of power loss.

## Automatic termination of calls

This setting determines after how many seconds calls to the PA1 will be terminated. The default setting is 300 seconds.

1. Open the PA1's web interface.
2. Click on **Preferences** in the menu on the left side of the window page. The "Preferences" page opens.
3. In the **PA1 Controls** section, enter the number of seconds in the text field of **Phone ends call after set seconds**.

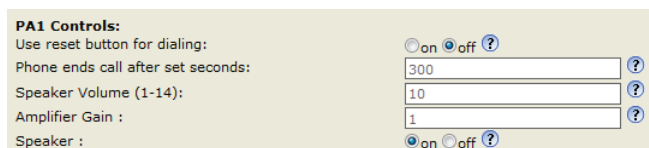

**PA1 Controls:**  
Use reset button for dialing:  on  off ?  
Phone ends call after set seconds:  ?  
Speaker Volume (1-14):  ?  
Amplifier Gain :  ?  
Speaker :  on  off ?

4. Click on "Apply" at the bottom of the page.
5. After clicking on "Apply", the "Save" button will appear at the top of the page. Click on "Save" to save the changes permanently in case of power loss.

**Operation**  
Home  
Directory



 **Some settings are not yet stored permanently.** [Save](#) [View Changes](#) ?

## Adjusting the volume and the amplifier gain

1. Open the PA1's web interface.
2. Click on **Preferences** in the menu on the left side of the window page. The "Preferences" page opens.
3. You can change the default settings for speaker volume and amplifier gain in the **PA1 Controls** section.
  - **Speaker Volume:** Enter a number between 1 (low) and 14 (high) in the text field. The default setting is 10.
  - **Amplifier Gain:** Enter 0 or 1 in the text field. The default setting is 1.
4. Click on "Apply" at the bottom of the page.
5. After clicking on "Apply", the "Save" button will appear at the top of the page. Click on "Save" to save the changes permanently in case of power loss.

# Using the snom PA1

## Making announcements

Dial the phone number of the PA1 and, when your phone shows that you are connected, speak your announcement into its handset/headset/casing microphone. When you are done, terminate the call by hanging up or pressing the  /  key.

## Turning the loudspeaker on or off

1. Open the PA1's web interface.
2. Click on **Preferences** in the menu on the left side of the window page. The "Preferences" page opens.
3. In the **PA1 Controls** section click on the radio buttons **on/off** to turn the loudspeaker on or off.

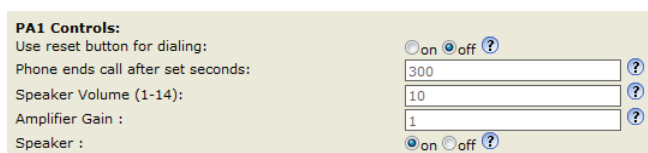

**PA1 Controls:**  
Use reset button for dialing:  on  off ?  
Phone ends call after set seconds:  ?  
Speaker Volume (1-14):  ?  
Amplifier Gain :  ?  
Speaker :  on  off ?

4. Click on "Apply" at the bottom of the page. Then click on "Save" at the top of the page to save the changes permanently in case of power loss.

# Software update

Software updates can be done through provisioning from the server whose setting URL is specified on the PA1's web interface or by means of a manual update.

**CAUTION:** Cutting off the device's power during a firmware update (red LED on, green LED off) will damage the firmware and render the PA1 inoperational. In such a case, the PA1 will need to be returned to the vendor for a reset (special kit required).

**Do NOT** remove the device's power supply (Ethernet cable when using PoE, power adapter when not using PoE) when the red light is on or blinking; a firmware update is ongoing.

### LED indications

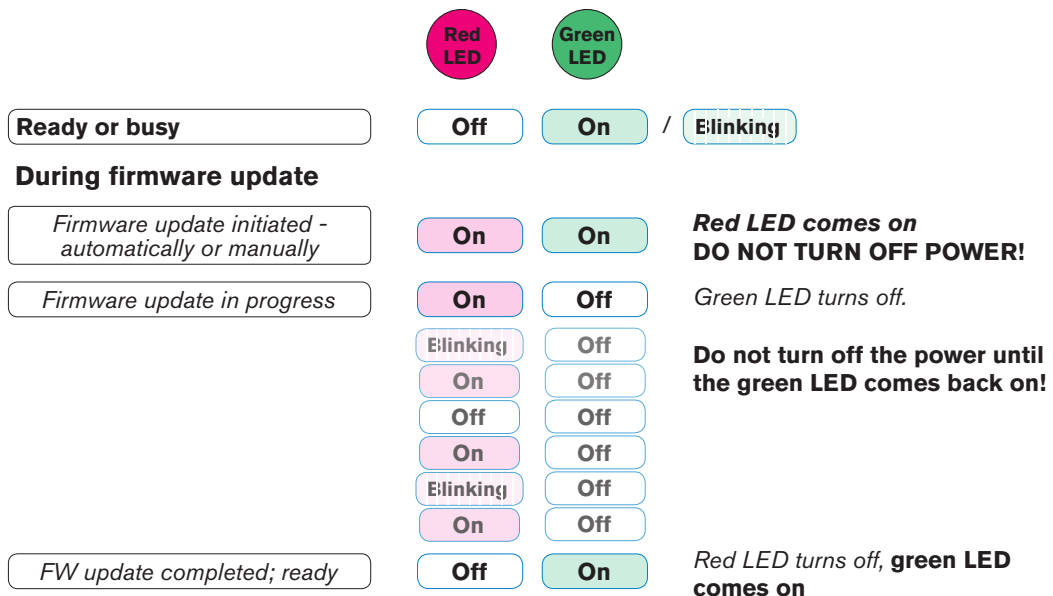

Fig. 1

## Provisioning software updates

Provisioning of updates can be done in two ways:

- Fully automatic with the setting **Update automatically**: Whenever a new firmware version is made available, the settings are downloaded from the settings server and the update is started automatically.
- Semi-automatic with the setting **Ask for update**: The settings are downloaded from the settings server automatically, but you are prompted to confirm any available update.

- Open the PA1's web interface.
- Click on **Advanced** in the menu on the left side of the window page. The "Advanced Settings" page opens.

- Click on the **Update** tab.

- Select **Update automatically** or **Ask for update** from the list box of **Update policy**.
- Enter the settings server's URL in the text field of **Setting URL**.
- Click the **on** radio button of **PnP Config**.
- Click on "Apply" at the bottom of the page. Then click on "Save" at the top of the page to save the changes permanently in case of power loss.

## Manual software update

If the current setting is updating through provisioning, whether automatically or semi-automatically, you must first change these settings.

### Settings

- Open the PA1's web interface.
- Click on **Advanced** in the menu on the left side of the window page. The "Advanced Settings" page opens.
- Click on the **Update** tab.

- Select **Never update, do not load settings** from the list box of **Update policy**.
- Click the **off** radio button of **PnP Config**.
- Click on "Apply" at the bottom of the page. Then click on "Save" at the top of the page to save the changes permanently in case of power loss.
- Click "Reboot" and confirm with "Yes".

### Updating manually

- Open the PA1's web interface.
- Click on **Software Update** in the menu on the left side of the window page. The page "Manual Software Update" opens.

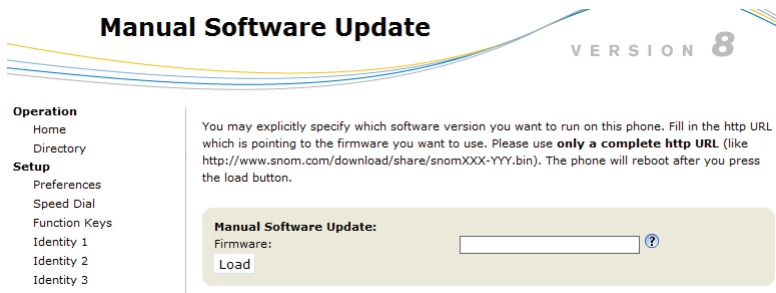

3. Enter the firmware link in the text field of **Upload Setting file manually**. Obtaining the firmware link:

- a. Open snom's web page at www.snom.com.
- b. Click on Support > Download Firmware.



c. The Wiki page "Category Firmware" opens. Click on "snom PA1 Update Guide".

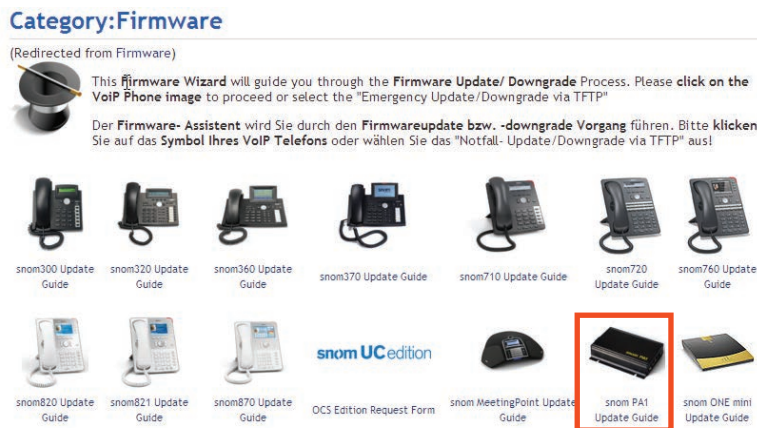

d. The snom PA1 "Firmware" page opens. Click on "Firmware version 8".



- e. The snom PA1 "Firmware/V8" page opens. Click on **Manual Update to Version ...**

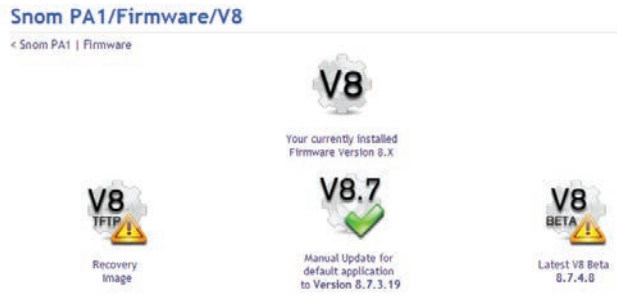

- f. The "Firmware/V8/PA1" page opens. Right-click on the version's link, then click on **Copy shortcut** in the context menu.

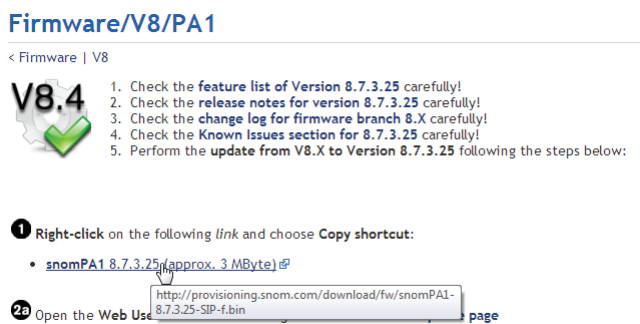

- g. On the Manual Software Update page of the PA1, place the cursor into the textfield of **Firmware**, right-click, and click on **Paste**.

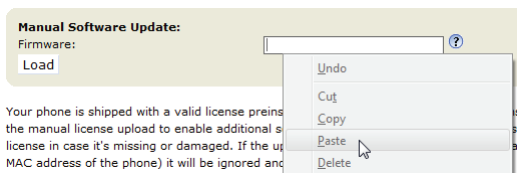

- 4. Click on **Load**.

The PA1 starts the firmware update, indicated by the red LED lighting up and the green LED going out. The firmware update is done when the red LED goes out and the green LED comes back on.

**CAUTION:** Cutting off the device's power during a firmware update (red LED on, green LED off) will damage the firmware and render the PA1 inoperational.

**Do NOT** remove the device's power supply (Ethernet cable when using PoE, power adapter when not using PoE) while a firmware update is ongoing.

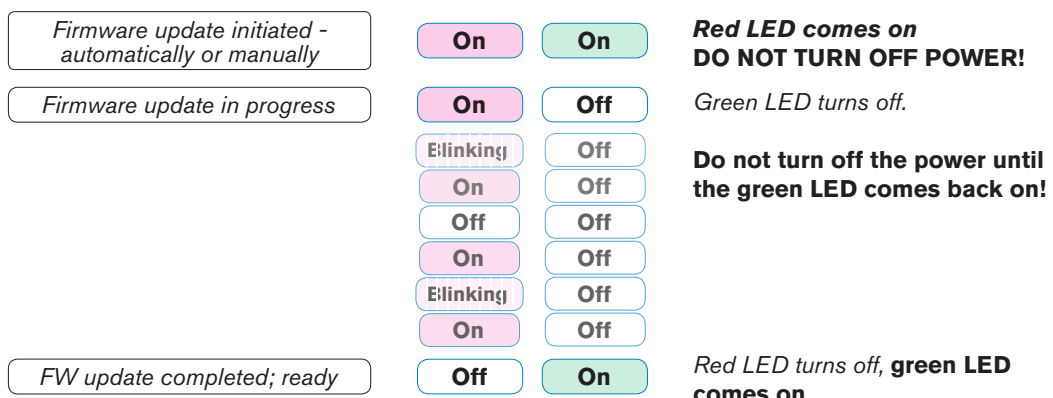

# Troubleshooting

## Reboot

1. Open the PA1's web interface.
2. Click on **Advanced** in the menu on the left side of the window page. The "Advanced Settings" page opens.
3. Click on the **Update** tab.
4. Click on "Reboot" and confirm with "Yes". The red LED lights up, and the green LED goes out. When the PA1 has finished rebooting, the red LED goes out, the green LED lights up, and the web interface is available again.

## Hard reboot

Disconnect the power, wait for a few seconds, and reconnect.

**Warning: Never disconnect the power during a firmware update!** Cutting off the device's power during a firmware update (red LED on, green LED off) will damage the firmware and render the PA1 inoperational.

In such a case, the PA1 will need to be returned to the vendor for resetting (special kit required).

**Do NOT** remove the device's power supply (Ethernet cable when using PoE, power adapter when not using PoE) when the red light is on or blinking; a firmware update is ongoing.

### LED indications

	Red LED	Green LED	
Ready or busy	Off	On	Elinking
<b>During firmware update</b>			
<i>Firmware update initiated - automatically or manually</i>	On	On	<b>Red LED comes on DO NOT TURN OFF POWER!</b>
<i>Firmware update in progress</i>	On	Off	<i>Green LED turns off.</i>
	Elinking	Off	<b>Do not turn off the power until the green LED comes back on!</b>
	On	Off	
	Off	Off	
	On	Off	
	Elinking	Off	
	On	Off	
<i>FW update completed; ready</i>	Off	On	<i>Red LED turns off, green LED comes on</i>

## Reset to factory values

Press the "IP/Reset" button to the left of the LEDs.

**Warning:** All customized settings will be lost! See "Initializing and Configuring the PA" on page 10 for information on how to initialize and configure the PA1 anew.

## Contacting snom Support

Please visit our knowledge base and our forum first. You may find the answer to your question in one of the topics there. If you haven't found an answer or a solution to your problem, please post your question or problem on the forum (<http://forum.snom.com>).

**Note:** The forum is accessible to the general public. Do not post any private and/or security-relevant information there. This includes MAC addresses, SIP headers, etc. that may allow others to hack into your system or use your identity for nefarious purposes.

If you haven't received an answer or solution within a reasonable amount of time (generally two work days), send the link to your posting to Support. You need to create a support account first, if you don't already have one.

### Creating a support account

1. Open snom's web page at [www.snom.com](http://www.snom.com).
2. Click on the Support tab to open the Support window.
3. Click on End Customer Support.
4. On the Support Center page, click on Register new account.
5. Fill out the form and click Register.
6. You will receive an automatic email. Click on the link to activate your account.
7. You will receive a second email containing your account name, email address, and password.

You can now submit tickets requesting support to snom Support.

### Submitting a ticket

1. Open snom's web page at [www.snom.com](http://www.snom.com).
2. Click on the Support tab to open the Support window.
3. Click on End Customer Support.
4. On the Support Center page, enter your email address and password and click on Login.
5. Click on "Ask for support".
6. Follow the instructions on the screen.



## Submitting system and settings information

### System information

1. Open the phone's web interface > Status > System Information.
2. Copy the text under System Information into your forum posting or into the email, if Support has asked you to contact them by email.

Make sure to delete the MAC address and the IP address, if the posting or e-mail can be read by the public.

### System information

Open the phone's web interface > Status > Settings. Make sure to delete private and/or security-relevant information like the MAC address, public IP address, etc.

## Traces

snom Support may ask you to submit a SIP Trace and/or a PCAP Trace to help them analyze your problem.

### Performing a SIP Trace

1. Open the phone's web interface > Status > SIP Trace.
2. Click on "Clear" to clear the page.
3. Recreate the error to be documented in the trace.
4. Click on "Reload".
5. Copy the text and submit to Support in whatever form they requested you to use.

### Performing a PCAP Trace

1. Open the phone's web interface > Status > PCAP Trace.
2. Click on "Start" to start recording network traffic.
3. Click on Stop to end recording.
4. Click on the "here" link to open the file download window and save the file.
5. Submit the file to Support in whatever way they requested you to use.

Appendix 1 - Drilling Template PA1 Wallmounting

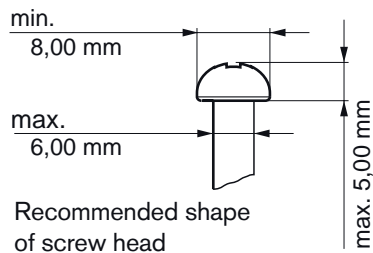
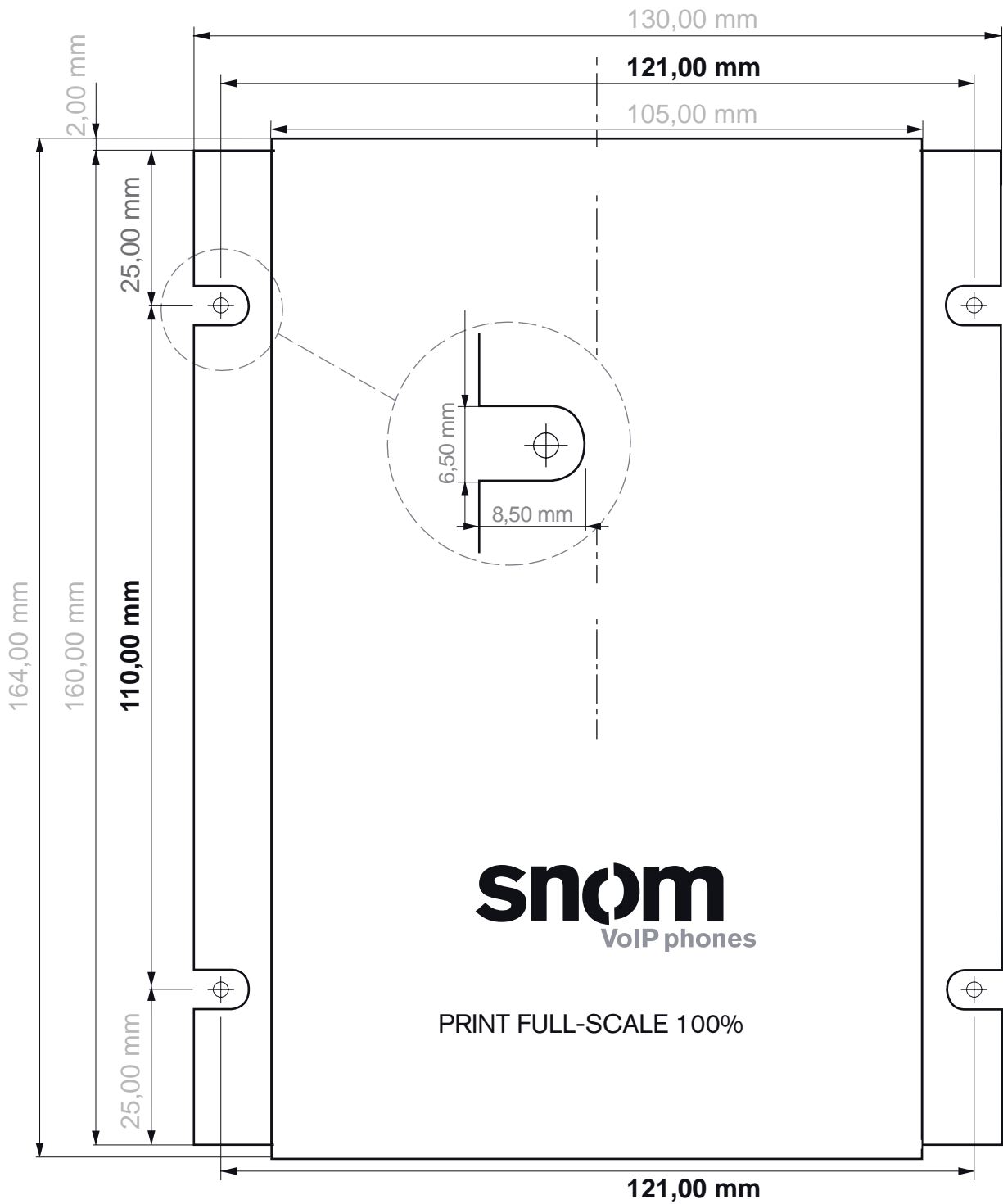

4 x

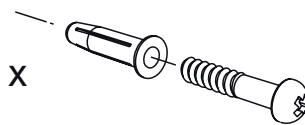

Use screws and expansion  
anchors suitable for your  
wall

### COPYRIGHT NOTICE AND WARRANTY DISCLAIMER

I.

Das Produkt enthält Software, die unter der GNU General Public License, Version 2, frei genutzt werden darf.

This Product contains Software applicable to GNU General Public License, Version 2 which can be used freely.

II.

Im Verhältnis zu den Lizenzgebern der Software gilt der folgende Haftungsausschluss:

Towards the licensor of this Software the following liability is disclaimed:

This program is distributed in the hope that it will be useful, but WITHOUT ANY WARRANTY; without even the implied warranty of MERCHANTABILITY or FITNESS FOR A PARTICULAR PURPOSE. See the GNU General Public License for more details.

III.

Der Lizenztext der GPL lautet wie folgt:  
The GNU General Public License is as follows:

### GNU GENERAL PUBLIC LICENSE Version 2, June 1991

Copyright (C) 1989, 1991  
Free Software Foundation, Inc.  
59 Temple Place, Suite 330  
Boston, MA 02111-1307, USA

Everyone is permitted to copy and distribute verbatim copies of this license document, but changing it is not allowed.

#### Preamble

The licenses for most software are designed to take away your freedom to share and change it. By contrast, the GNU General Public License is intended to guarantee your freedom to share and change free software--to make sure the software is free for all its users. This General Public License applies to most of the Free Software Foundation's software and to any other program whose authors commit to using it. (Some other Free Software Foundation software is covered by the GNU Library General Public License instead.) You can apply it to your programs, too.

When we speak of free software, we are referring to freedom, not price. Our General Public Licenses are designed to make sure that you have the freedom to distribute copies of free software (and charge for this service if you wish), that you receive source code or can get it if you want it, that you can change the software or use pieces of it in new free programs; and that you know you can do these things.

To protect your rights, we need to make restrictions that forbid anyone to deny you these rights or to ask you to surrender the rights. These restrictions translate to certain responsibilities for you if you distribute copies of the software, or if you modify it. For example, if you distribute copies of such a program, whether gratis or for a fee, you must give the recipients all the rights that you have. You must make sure that they, too, receive or can get the source code. And you must show them these terms so they know their rights.

We protect your rights with two steps: (1) copyright the software, and (2) offer you this license which gives you legal permission to copy, distribute and/or modify the software.

Also, for each author's protection and ours, we want to make certain that everyone understands that there is no warranty for this free software. If the software is modified by someone else and passed on, we want its recipients to know that what they have is not the original, so that any problems introduced by others will not reflect on the original authors' reputations.

Finally, any free program is threatened constantly by software patents. We wish to avoid the danger that redistributors of a free program will individually obtain patent licenses, in effect making the program proprietary. To prevent this, we have made it clear that any patent must be licensed for everyone's free use or not licensed at all.

The precise terms and conditions for copying, distribution and modification follow.

### GNU GENERAL PUBLIC LICENSE

#### TERMS AND CONDITIONS FOR COPYING, DISTRIBUTION AND MODIFICATION

0. This License applies to any program or other work which contains a notice placed by the copyright holder saying it may be distributed under the terms of this General Public License. The "Program", below, refers to any such program or work, and a "work based on the Program" means either the Program or any derivative work under copyright law: that is to say, a work containing the Program or a portion of it, either verbatim or with modifications and/or translated into another language. (Hereinafter, translation is included without limitation in the term "modification".) Each licensee is addressed as "you".

Activities other than copying, distribution and modification are not covered by this License; they are outside its scope. The act of running the Program is not restricted, and the output from the Program is covered only if its contents constitute a work based on the Program (independent of having been made by running the Program). Whether that is true depends on what the Program does.

1. You may copy and distribute verbatim copies of the Program's source code as you receive it, in any medium, provided that you conspicuously and appropriately publish on each copy an appropriate copyright notice and disclaimer of warranty; keep intact all the notices that refer to this License and to the absence of any warranty; and give any other recipients of the Program a copy of this License along with the Program.

You may charge a fee for the physical act of transferring a copy, and you may at your option offer warranty protection in exchange for a fee.

2. You may modify your copy or copies of the Program or any portion of it, thus forming a work based on the Program, and copy and distribute such modifications or work under the terms of Section 1 above, provided that you also meet all of these conditions:

a) You must cause the modified files to carry prominent notices stating that you changed the files and the date of any change.

b) You must cause any work that you distribute or publish, that in whole or in part contains or is derived from the Program or any part thereof, to be licensed as a whole at no charge to all third parties under the terms of this License.

c) If the modified program normally reads commands interactively when run, you must cause it, when started running for such interactive use in the most ordinary way, to print or display an announcement including an appropriate copyright notice and a notice that there is no warranty (or else, saying that you provide a warranty) and that users may redistribute the program under these conditions, and telling the user how to view a copy of this License. (Exception:

if the Program itself is interactive but does not normally print such an announcement, your work based on the Program is not required to print an announcement.)

These requirements apply to the modified work as a whole. If identifiable sections of that work are not derived from the Program, and can be reasonably considered independent and separate works in themselves, then this License, and its terms, do not apply to those sections when you distribute them as separate works. But when you distribute the same sections as part of a whole which is a work based on the Program, the distribution of the whole must be on the terms of this License, whose permissions for other licensees extend to the entire whole, and thus to each and every part regardless of who wrote it.

Thus, it is not the intent of this section to claim rights or contest your rights to work written entirely by you; rather, the intent is to exercise the right to control the distribution of derivative or collective works based on the Program. In addition, mere aggregation of another work not based on the Program with the Program (or with a work based on the Program) on a volume of a storage or distribution medium does not bring the other work under the scope of this License.

3. You may copy and distribute the Program (or a work based on it, under Section 2) in object code or executable form under the terms of Sections 1 and 2 above provided that you also do one of the following:

- a) Accompany it with the complete corresponding machine-readable source code, which must be distributed under the terms of Sections 1 and 2 above on a medium customarily used for software interchange; or,
- b) Accompany it with a written offer, valid for at least three years, to give any third party, for a charge no more than your cost of physically performing source distribution, a complete machine-readable copy of the corresponding source code, to be distributed under the terms of Sections 1 and 2 above on a medium customarily used for software interchange; or,
- c) Accompany it with the information you received as to the offer to distribute corresponding source code. (This alternative is allowed only for noncommercial distribution and only if you received the program in object code or executable form with such an offer, in accord with Subsection b above.)

The source code for a work means the preferred form of the work for making modifications to it. For an executable work, complete source code means all the source code for all modules it contains, plus any associated interface definition files, plus the scripts used to control compilation and installation of the executable. However, as a special exception, the source code distributed need not include anything that is normally distributed (in either source or binary form) with the major components (compiler, kernel, and so on) of the operating system on which the executable runs, unless that component itself accompanies the executable.

If distribution of executable or object code is made by offering access to copy from a designated place, then offering equivalent access to copy the source code from the same place counts as distribution of the source code, even though third parties are not compelled to copy the source along with the object code.

4. You may not copy, modify, sublicense, or distribute the Program except as expressly provided under this License. Any attempt otherwise to copy, modify, sublicense or distribute the Program is void, and will automatically terminate your rights under this License. However, parties who have received copies, or rights, from you under this License will not have their licenses terminated so long as such parties remain in full compliance.

5. You are not required to accept this License, since you have not signed it. However, nothing else grants you permission to modify or distribute the Program or its derivative works. These actions

are prohibited by law if you do not accept this License. Therefore, by modifying or distributing the Program (or any work based on the Program), you indicate your acceptance of this License to do so, and all its terms and conditions for copying, distributing or modifying the Program or works based on it.

6. Each time you redistribute the Program (or any work based on the Program), the recipient automatically receives a license from the original licensor to copy, distribute or modify the Program subject to these terms and conditions. You may not impose any further restrictions on the recipients' exercise of the rights granted herein. You are not responsible for enforcing compliance by third parties to this License.

7. If, as a consequence of a court judgment or allegation of patent infringement or for any other reason (not limited to patent issues), conditions are imposed on you (whether by court order, agreement or otherwise) that contradict the conditions of this License, they do not excuse you from the conditions of this License. If you cannot distribute so as to satisfy simultaneously your obligations under this License and any other pertinent obligations, then as a consequence you may not distribute the Program at all. For example, if a patent license would not permit royalty-free redistribution of the Program by all those who receive copies directly or indirectly through you, then the only way you could satisfy both it and this License would be to refrain entirely from distribution of the Program.

If any portion of this section is held invalid or unenforceable under any particular circumstance, the balance of the section is intended to apply and the section as a whole is intended to apply in other circumstances.

It is not the purpose of this section to induce you to infringe any patents or other property right claims or to contest validity of any such claims; this section has the sole purpose of protecting the integrity of the free software distribution system, which is implemented by public license practices. Many people have made generous contributions to the wide range of software distributed through that system in reliance on consistent application of that system; it is up to the author/donor to decide if he or she is willing to distribute software through any other system and a licensee cannot impose that choice. This section is intended to make thoroughly clear what is believed to be a consequence of the rest of this License.

8. If the distribution and/or use of the Program is restricted in certain countries either by patents or by copyrighted interfaces, the original copyright holder who places the Program under this License may add an explicit geographical distribution limitation excluding those countries, so that distribution is permitted only in or among countries not thus excluded. In such case, this License incorporates the limitation as if written in the body of this License.

9. The Free Software Foundation may publish revised and/or new versions of the General Public License from time to time. Such new versions will be similar in spirit to the present version, but may differ in detail to address new problems or concerns. Each version is given a distinguishing version number. If the Program specifies a version number of this License which applies to it and "any later version", you have the option of following the terms and conditions either of that version or of any later version published by the Free Software Foundation. If the Program does not specify a version number of this License, you may choose any version ever published by the Free Software Foundation.

10. If you wish to incorporate parts of the Program into other free programs whose distribution conditions are different, write to the author to ask for permission. For software which is copyrighted by the Free Software Foundation, write to the Free Software Foundation; we sometimes make exceptions for this. Our decision will be guided by the two goals of preserving the free status of all derivatives of our free software and of promoting the sharing and reuse of software generally.

## NO WARRANTY

11. BECAUSE THE PROGRAM IS LICENSED FREE OF CHARGE, THERE IS NO WARRANTY FOR THE PROGRAM, TO THE EXTENT

PERMITTED BY APPLICABLE LAW. EXCEPT WHEN OTHERWISE STATED IN WRITING THE COPYRIGHT HOLDERS AND/OR OTHER PARTIES PROVIDE THE PROGRAM „AS IS“ WITHOUT WARRANTY OF ANY KIND, EITHER EXPRESSED OR IMPLIED, INCLUDING, BUT NOT LIMITED TO, THE IMPLIED WARRANTIES OF MERCHANTABILITY AND FITNESS FOR A PARTICULAR PURPOSE. THE ENTIRE RISK AS TO THE QUALITY AND PERFORMANCE OF THE PROGRAM IS WITH YOU. SHOULD THE PROGRAM PROVE DEFECTIVE, YOU ASSUME THE COST OF ALL NECESSARY SERVICING, REPAIR OR CORRECTION.

12. IN NO EVENT UNLESS REQUIRED BY APPLICABLE LAW OR AGREED TO IN WRITING WILL ANY COPYRIGHT HOLDER, OR ANY OTHER PARTY WHO MAY MODIFY AND/OR REDISTRIBUTE THE PROGRAM AS PERMITTED ABOVE, BE LIABLE TO YOU FOR DAMAGES, INCLUDING ANY GENERAL, SPECIAL, INCIDENTAL OR CONSEQUENTIAL DAMAGES ARISING OUT OF THE USE OR INABILITY TO USE THE PROGRAM (INCLUDING BUT NOT LIMITED TO LOSS OF DATA OR DATA BEING RENDERED INACCURATE OR LOSSES SUSTAINED BY YOU OR THIRD PARTIES OR A FAILURE OF THE PROGRAM TO OPERATE WITH ANY OTHER PROGRAMS), EVEN IF SUCH HOLDER OR OTHER PARTY HAS BEEN ADVISED OF THE POSSIBILITY OF SUCH DAMAGES.

END OF TERMS AND CONDITIONS

## How to Apply These Terms to Your New Programs

If you develop a new program, and you want it to be of the greatest possible use to the public, the best way to achieve this is to make it free software which everyone can redistribute and change under these terms.

To do so, attach the following notices to the program. It is safest to attach them to the start of each source file to most effectively convey the exclusion of warranty; and each file should have at least the "copyright" line and a pointer to where the full notice is found.

<one line to give the program's name and a brief idea of what it does>Copyright (C) <year> <name of author>

This program is free software; you can redistribute it and/or modify it under the terms of the GNU General Public License as published by the Free Software Foundation; either version 2 of the License, or (at your option) any later version.

This program is distributed in the hope that it will be useful, but WITHOUT ANY WARRANTY; without even the implied warranty of MERCHANTABILITY or FITNESS FOR A PARTICULAR PURPOSE. See the GNU General Public License for more details.

You should have received a copy of the GNU General Public License along with this program; if not, write to the Free Software Foundation, Inc., 59 Temple Place, Suite 330, Boston, MA 02111-1307 USA

IV.

Den vollständigen korrespondierenden Sourcecode der Software schickt Ihnen die snom technology AG auf Nachfrage gerne auf einem üblichen Datenträger gegen Erstattung der Herstellungskosten in Höhe von EUR 5,- zu.

Der vollständige korrespondierende Sourcecode kann auch über unsere Website unter [http://www.snom.com/gpl\\_.html?&L=0](http://www.snom.com/gpl_.html?&L=0) heruntergeladen werden.

If requested by you, the complete corresponding source code of the Software can be sent by snom technology AG on a standard data storage medium against the reimbursement of the manufacturing costs of EUR 5.- per unit.

The complete corresponding source code of the Software can also be downloaded from our web site [http://www.snom.com/gpl\\_.html?&L=0](http://www.snom.com/gpl_.html?&L=0).

V..

Weitere Informationen finden Sie auch unter <http://www.snom.com>.

For further information see <http://www.snom.com>.

snom technology AG  
Wittestr. 30 G  
13509 Berlin, Deutschland  
Tel. +49 30 39 83 3-0  
Fax +49 30 39 83 31 11  
info@snom.com, sales@snom.com

snom technology, Inc.  
18 Commerce Way, Suite 6000  
Woburn, MA 01801, USA  
Tel. 781-569-2044  
Fax 978-998-7883  
infoUSA@snom.com

snom UK Ltd  
Amethyst House, Meadowcroft Way  
Leigh Business Park, Leigh  
Manchester WN7 3XZ, UK  
Tel. +44 169 348 7500  
Fax +44 169 348 7509  
uksales@snom.com

snom France SARL  
6 Parc des fontenelles  
78870 Bailly, France  
Tel. +33 1 80 87 62 87  
Fax +33 1 80 87 62 88  
snom-fr@snom.com

snom technology SRL  
Via A. Lusardi 10  
20122 Milano, Italia  
Tel +39 02 00611212  
Fax +39 02 93661864  
snom-italy@snom.com

snom technology Ltd.  
Rm. A2, 3F, No. 37, Ln. 258  
Ruiguang Rd., Neihu Dist.  
Taipei City 114, Taiwan  
Tel +886-2-8751-1120  
Fax +886-2-8751-1130  
infoASIA@snom.com

**Your specialist retailer - Ihr Fachhändler -  
Votre distributeur - Su distribuidor - Il tuo rivenditore:**

